

2 PLAN @ LEVEL 1B  
SCALE: 3/16"=1'-0"

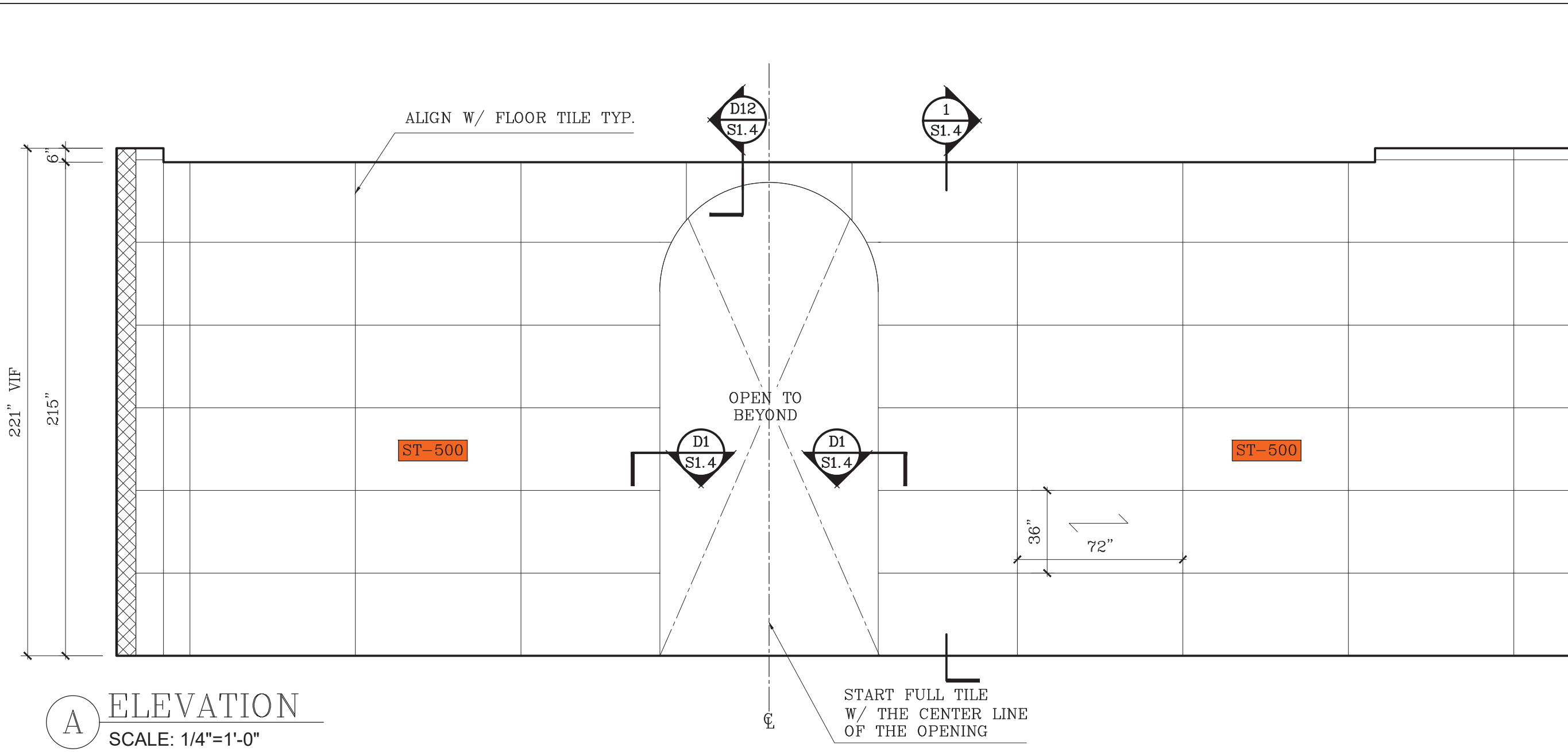

A ELEVATION  
SCALE: 1/4"=1'-0"

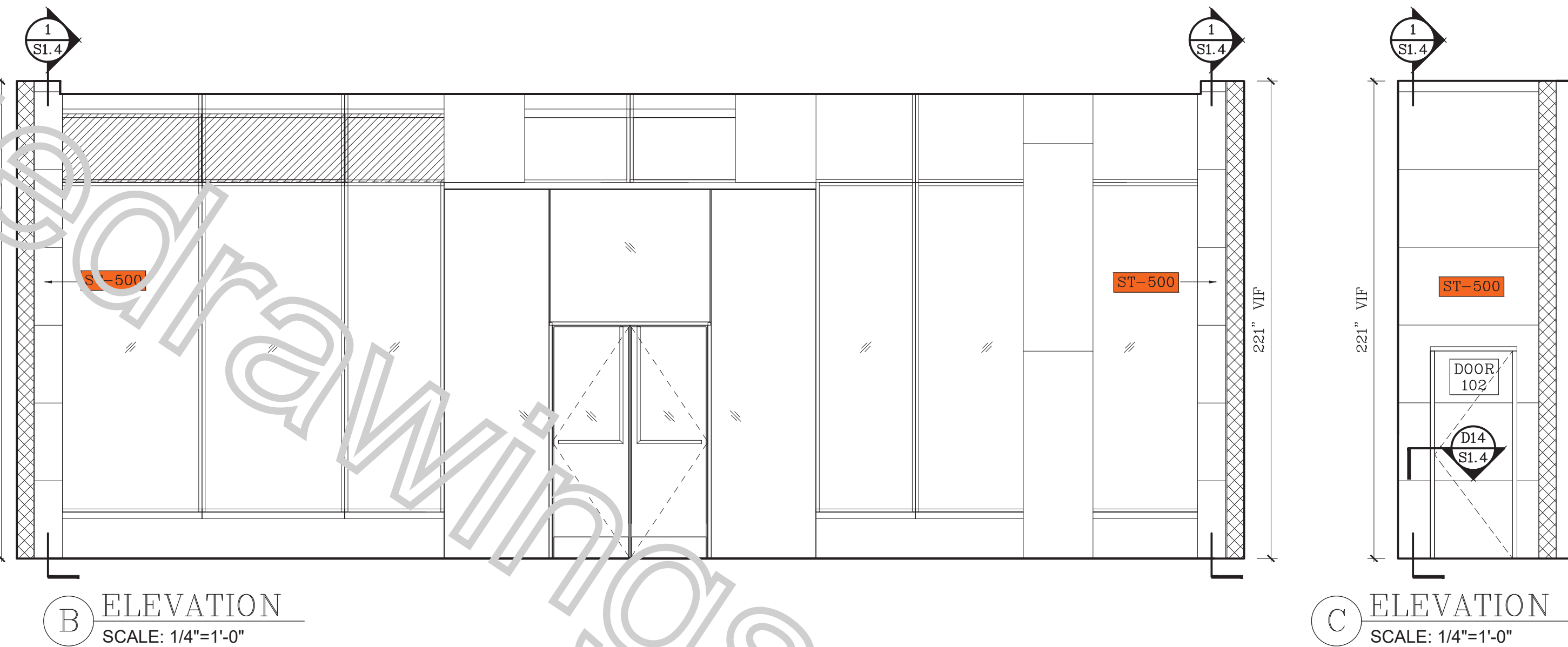

B ELEVATION  
SCALE: 1/4"=1'-0"

C ELEVATION  
SCALE: 1/4"=1'-0"

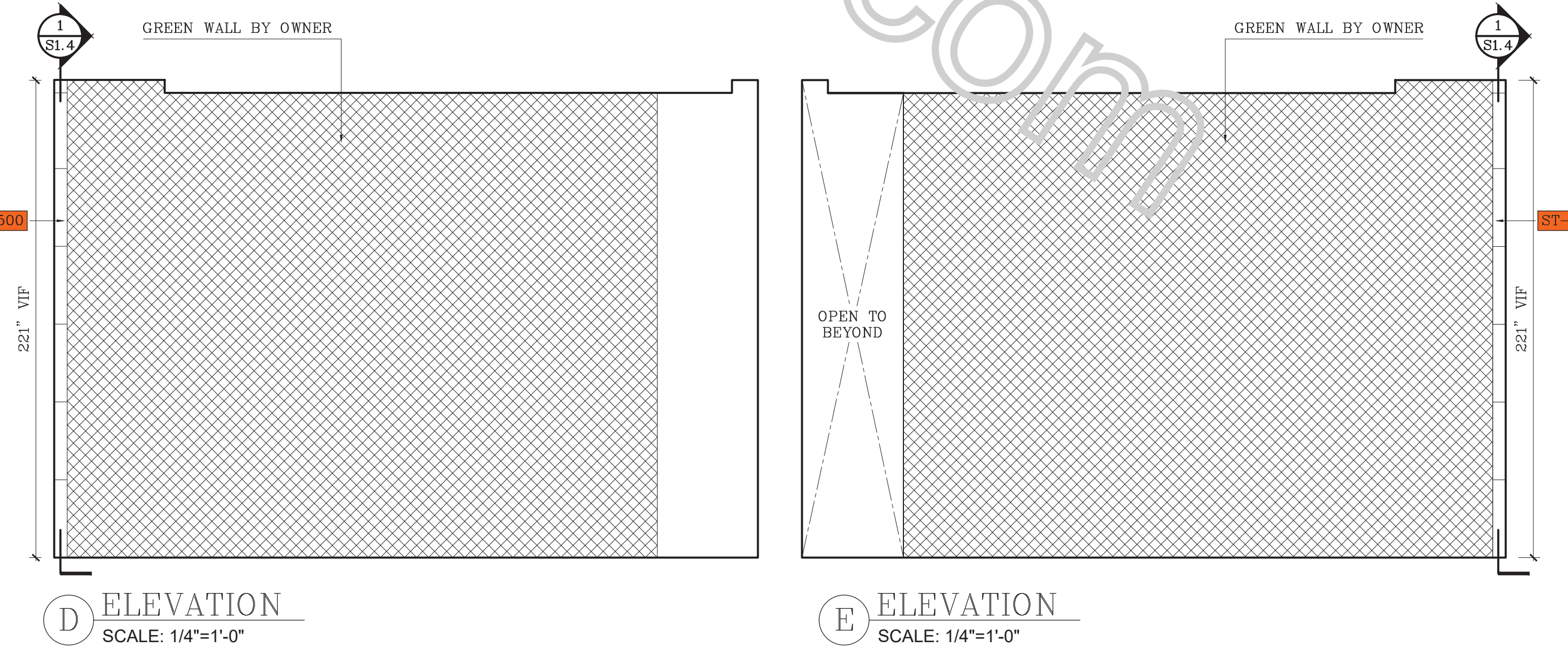

D ELEVATION  
SCALE: 1/4"=1'-0"

E ELEVATION  
SCALE: 1/4"=1'-0"

SPECIFICATIONS			
FINISHES			
ST-500	TRAVERTINE - MARE CLASSICO HONED		
HARDWARE			
FIXTURES			
APPROVED/NO CHANGES			
APPROVED/AS NOTED			
REVISE AS NOTED/RESUBMIT			
SIGNATURE		DATE	
REVISIONS			
Nr.	DATE	DESCRIPTION	BY OBS.
ONCE APPROVED, THIS DRAWING SUPERSEDES ALL PREVIOUS ARCHITECTURAL & SHOP DRAWINGS			
APPROVED BY:			
SIGNATURE		DATE	
ABBREVIATIONS			
AF=Above Fin Floor	FE=Finished End		
BS=Base	FF=Face Frame		
BC=Back	FO=Finished Opening		
CB=Cabinet	FP=Fixed Panel		
CAS=Casing	ID=Inner Dimension		
CL=Clear Opening	OD=Outer Dimension		
CTOP=Counter Top	PNL=Panel		
DB=Drawer Box	RO=Rough Opening		
DF=Drawer Face	POT=Pull Out Tray		
WF=Verify in Field	REM=Removable Panel		
FD=Field Dimension	SHF=Adj. Shelf		
PROJ	[Redacted Box]		
LOCAT			
COMP			
LEVEL 1 STONE SHOP DRWG.			
DWN BY: DAN	SCALE: AS NOTED	DWG. NO.: S1.1	
DATE: 08/15/2023			

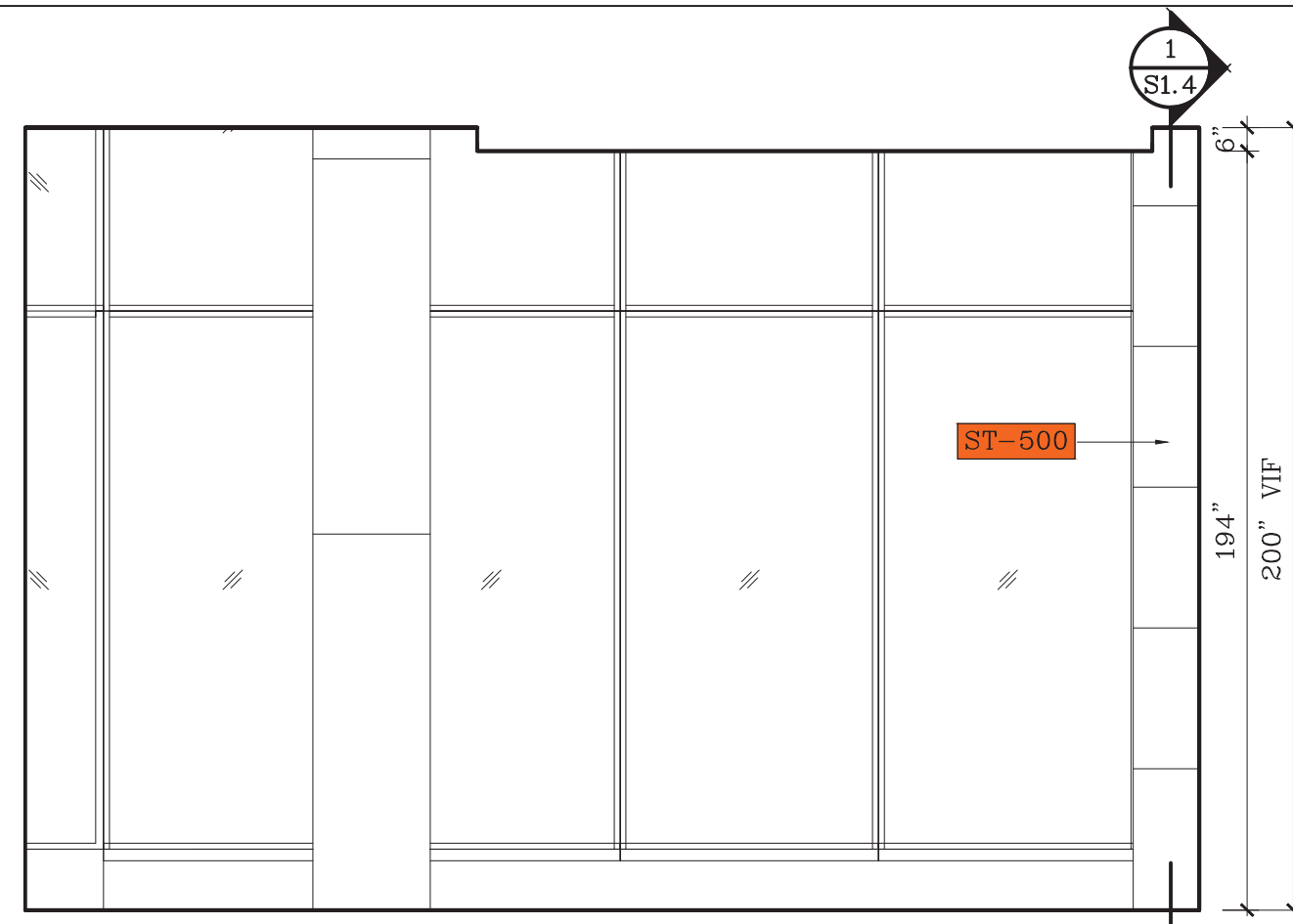

F ELEVATION  
SCALE: 1/4"=1'-0"

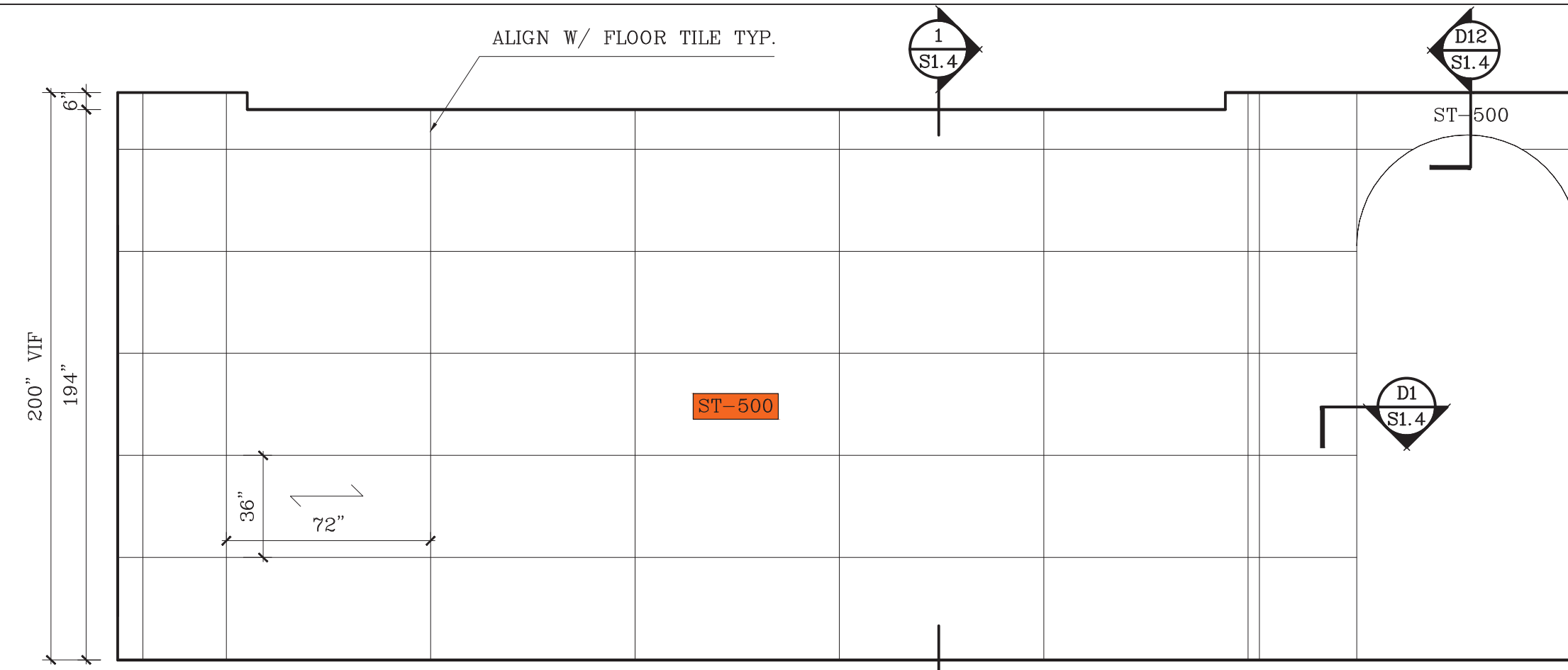

G ELEVATION  
SCALE: 1/4"=1'-0"

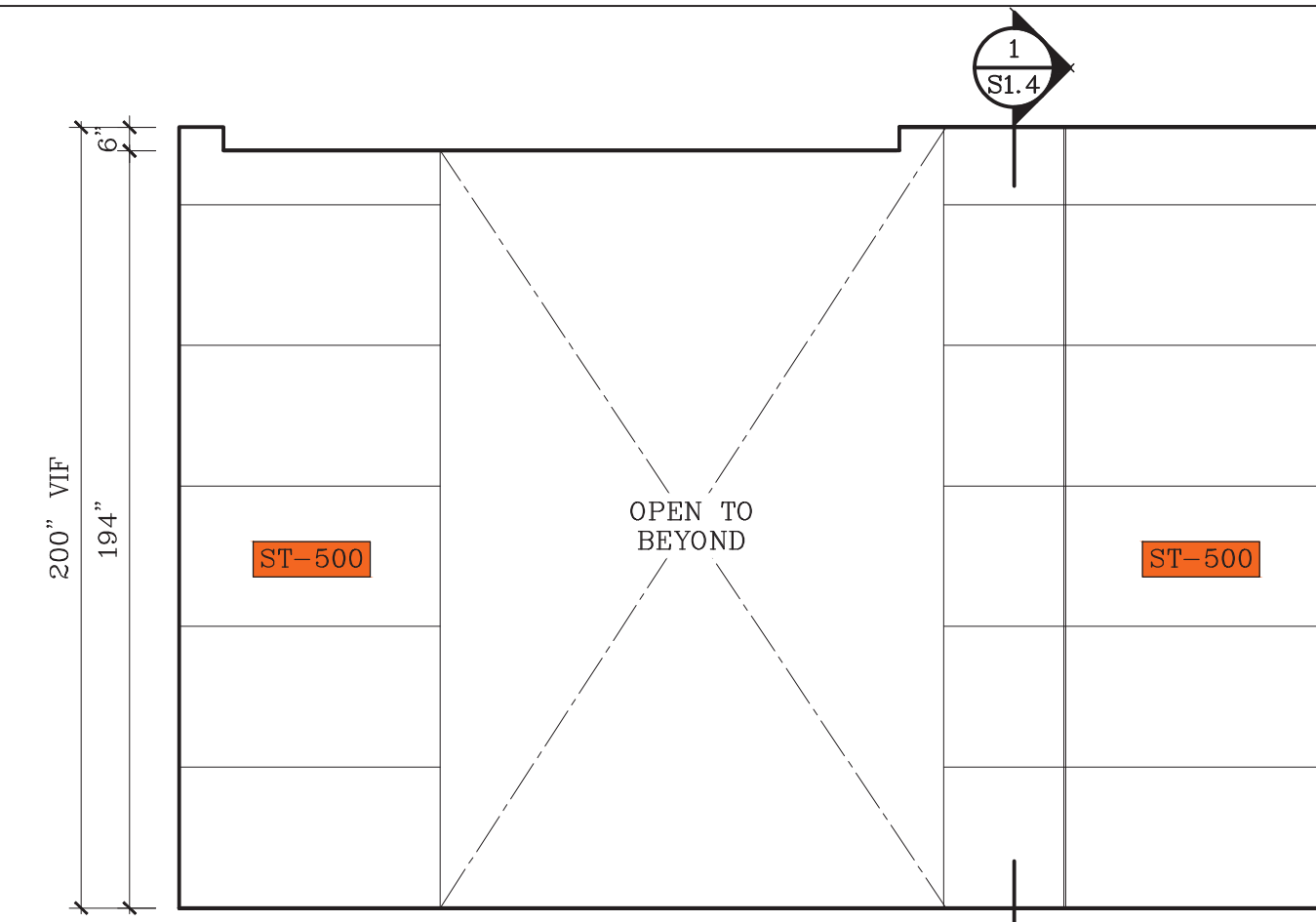

H ELEVATION  
SCALE: 1/4"=1'-0"

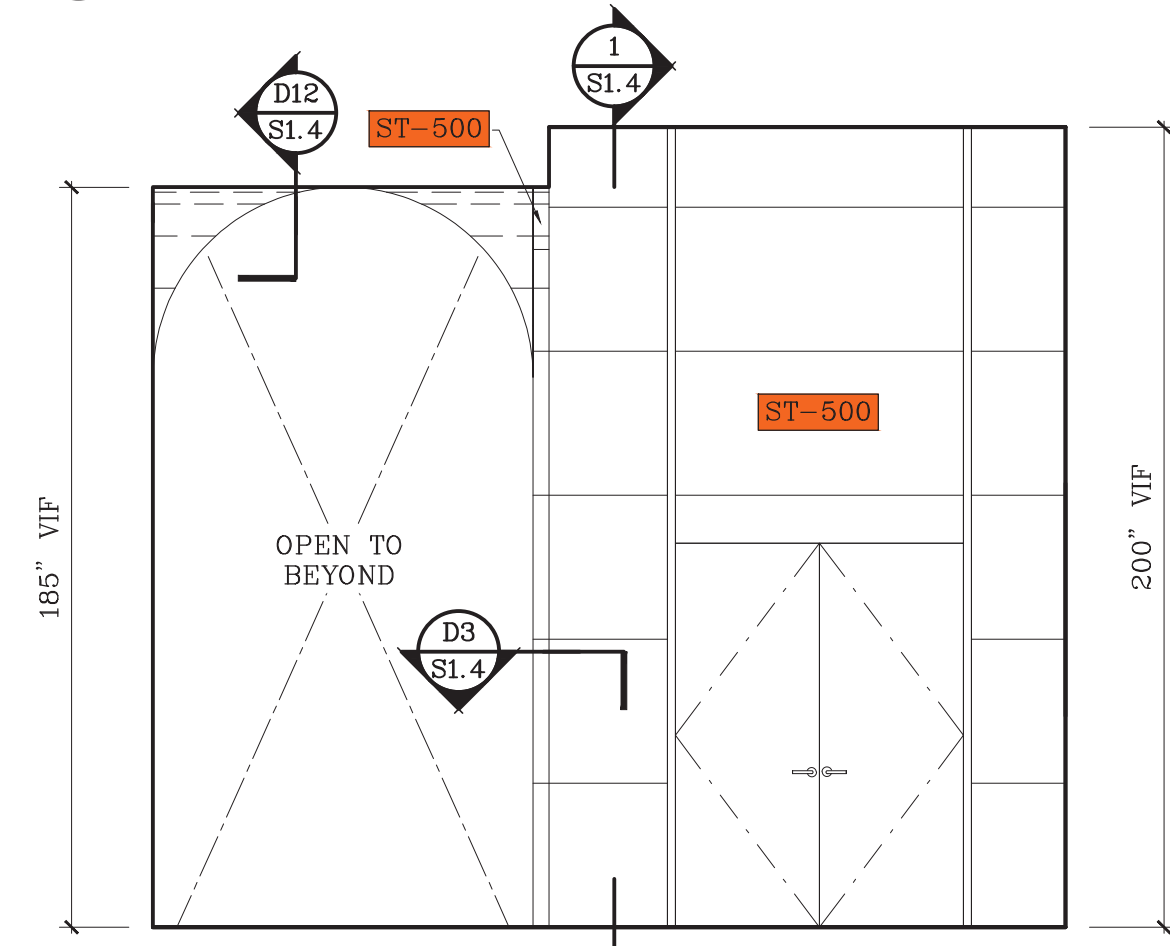

J ELEVATION  
SCALE: 1/4"=1'-0"

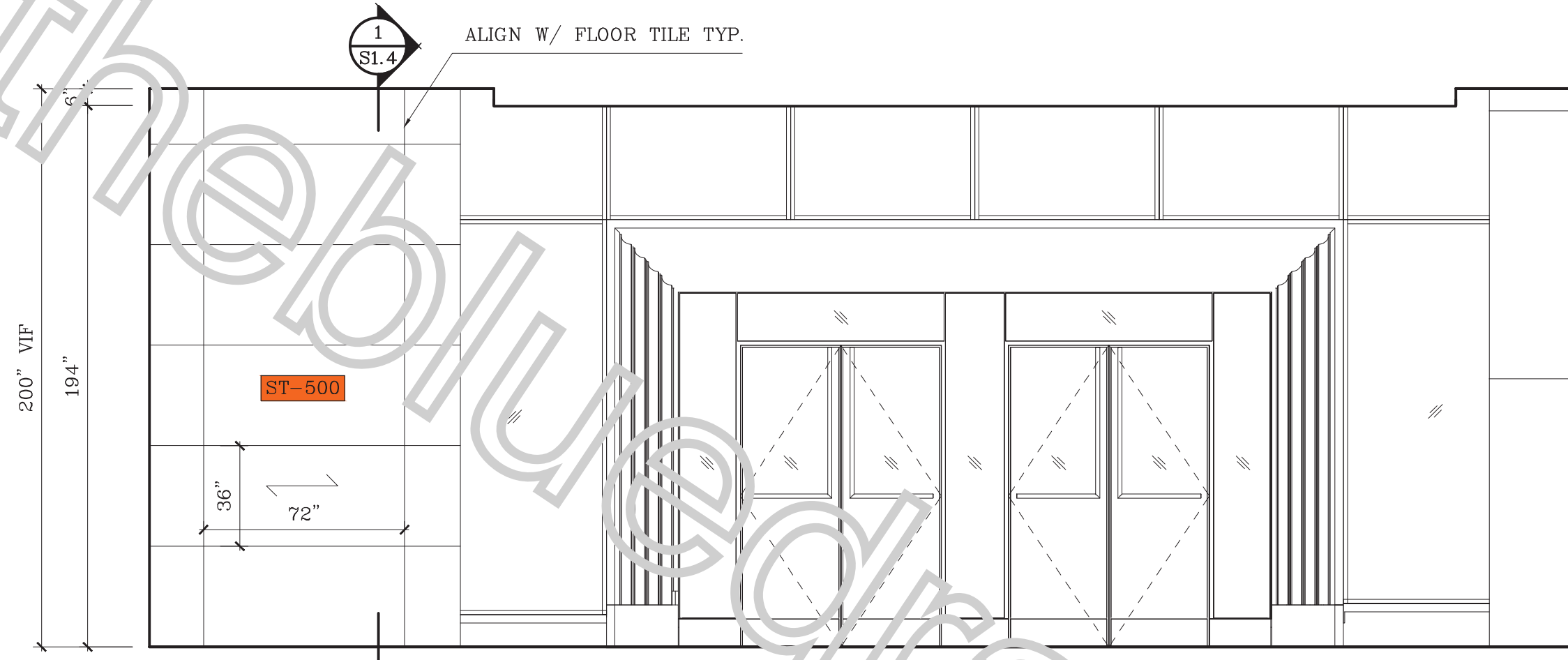

K ELEVATION  
SCALE: 1/4"=1'-0"

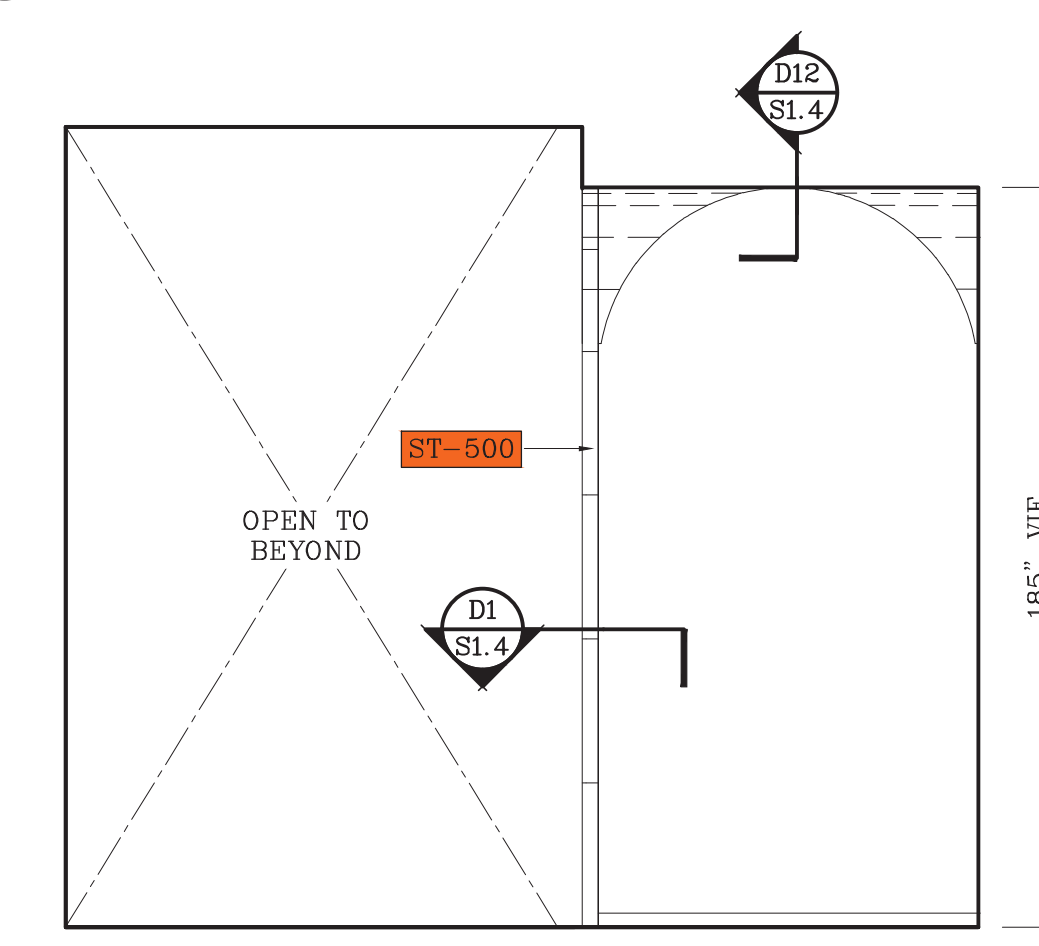

L ELEVATION  
SCALE: 1/4"=1'-0"

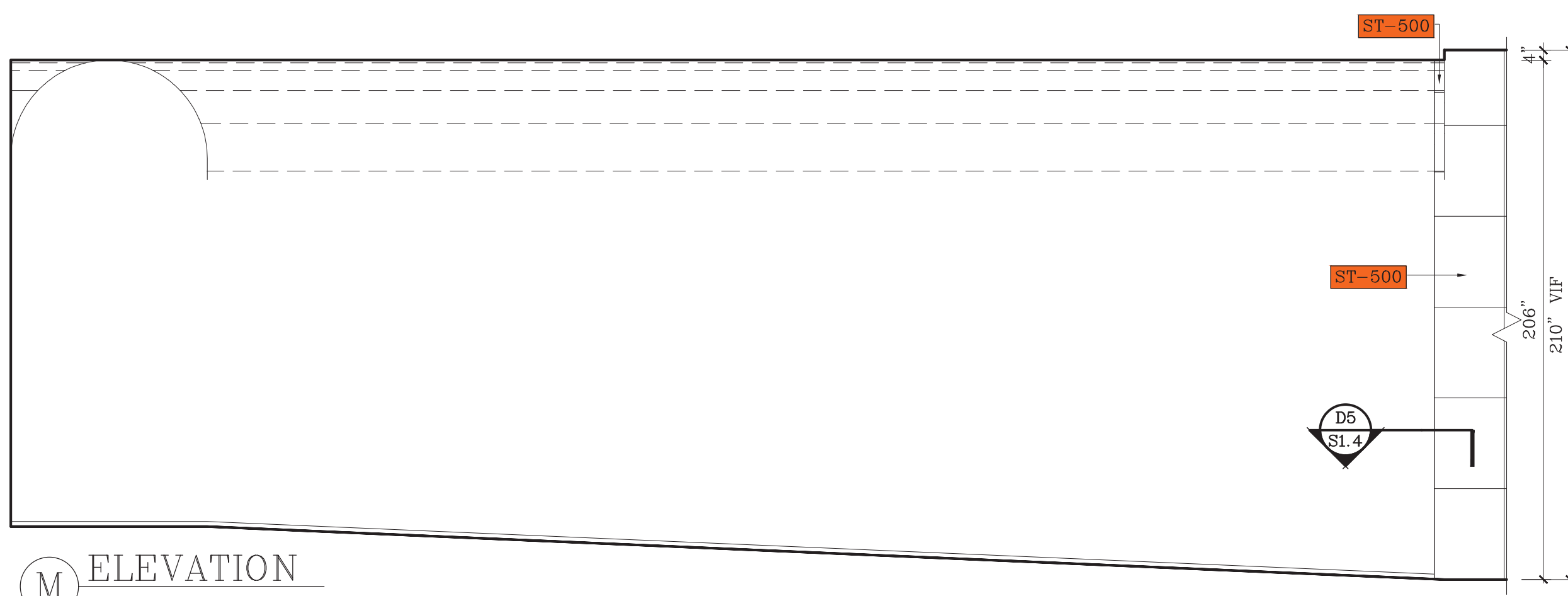

M ELEVATION  
SCALE: 1/4"=1'-0"

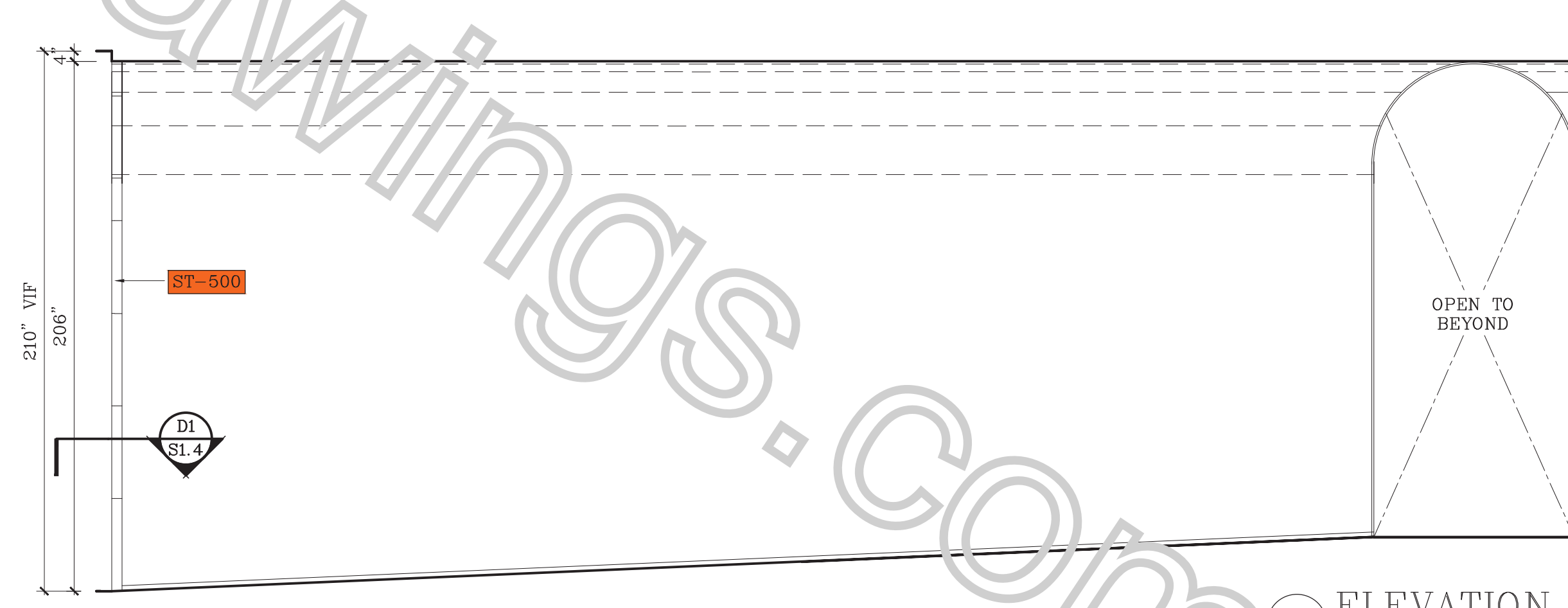

N ELEVATION  
SCALE: 1/4"=1'-0"

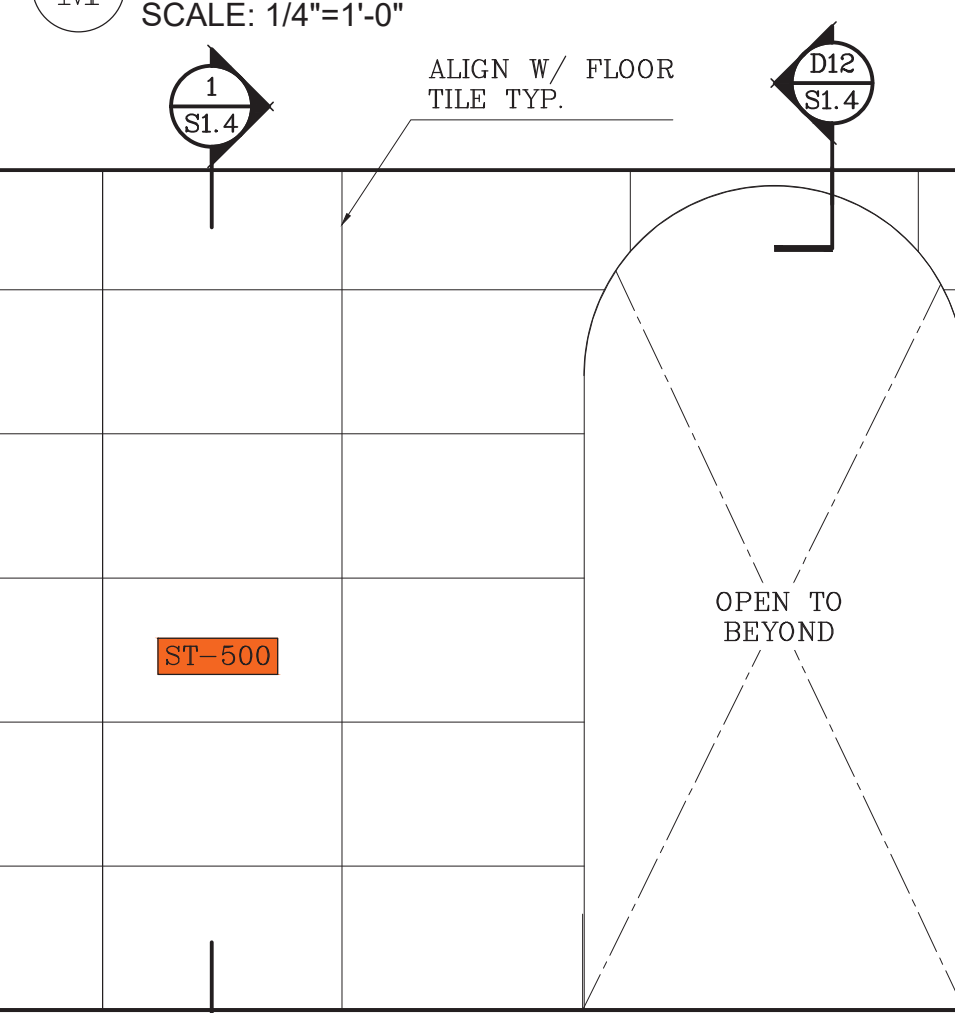

O ELEVATION  
SCALE: 1/4"=1'-0"

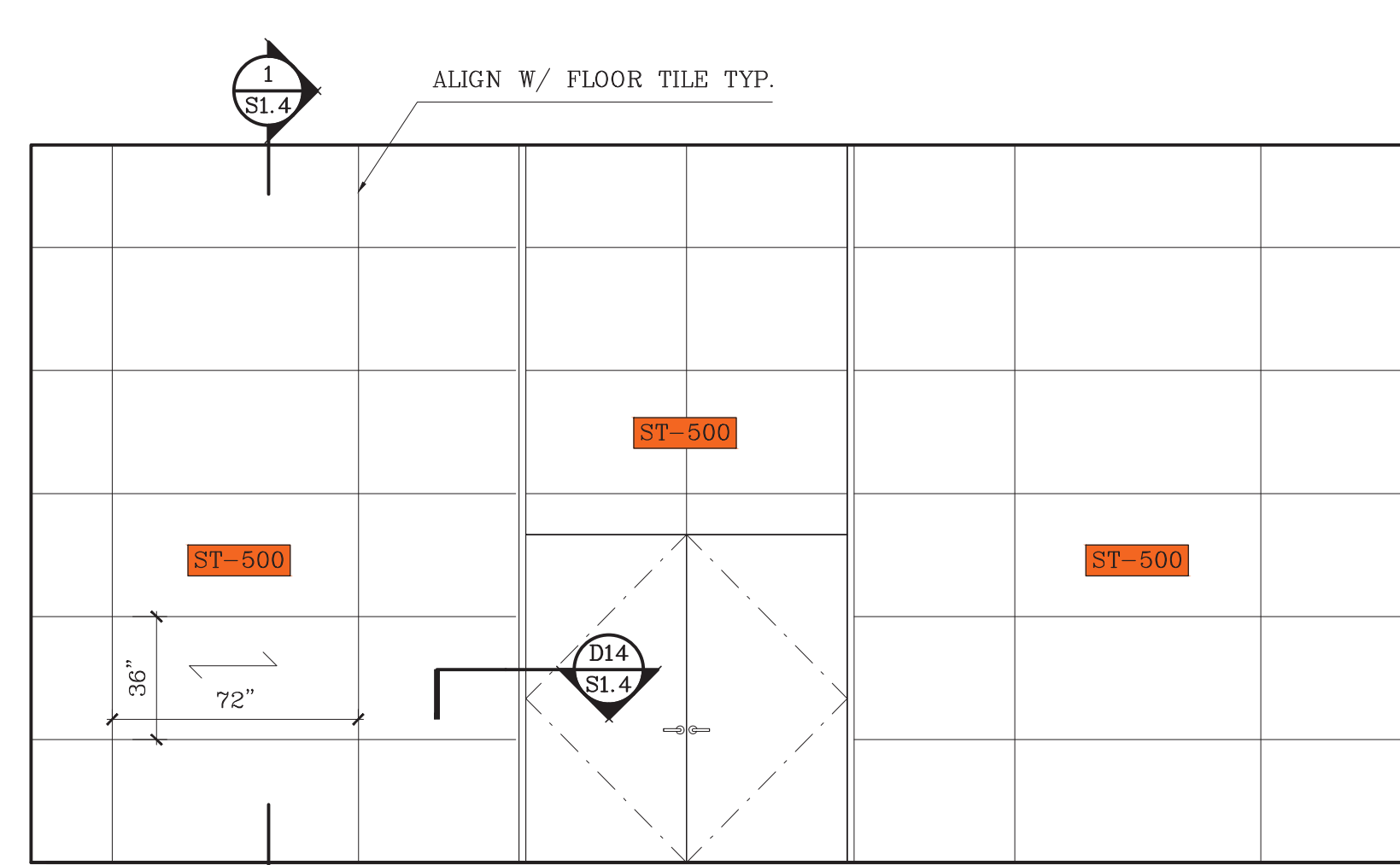

P ELEVATION  
SCALE: 1/4"=1'-0"

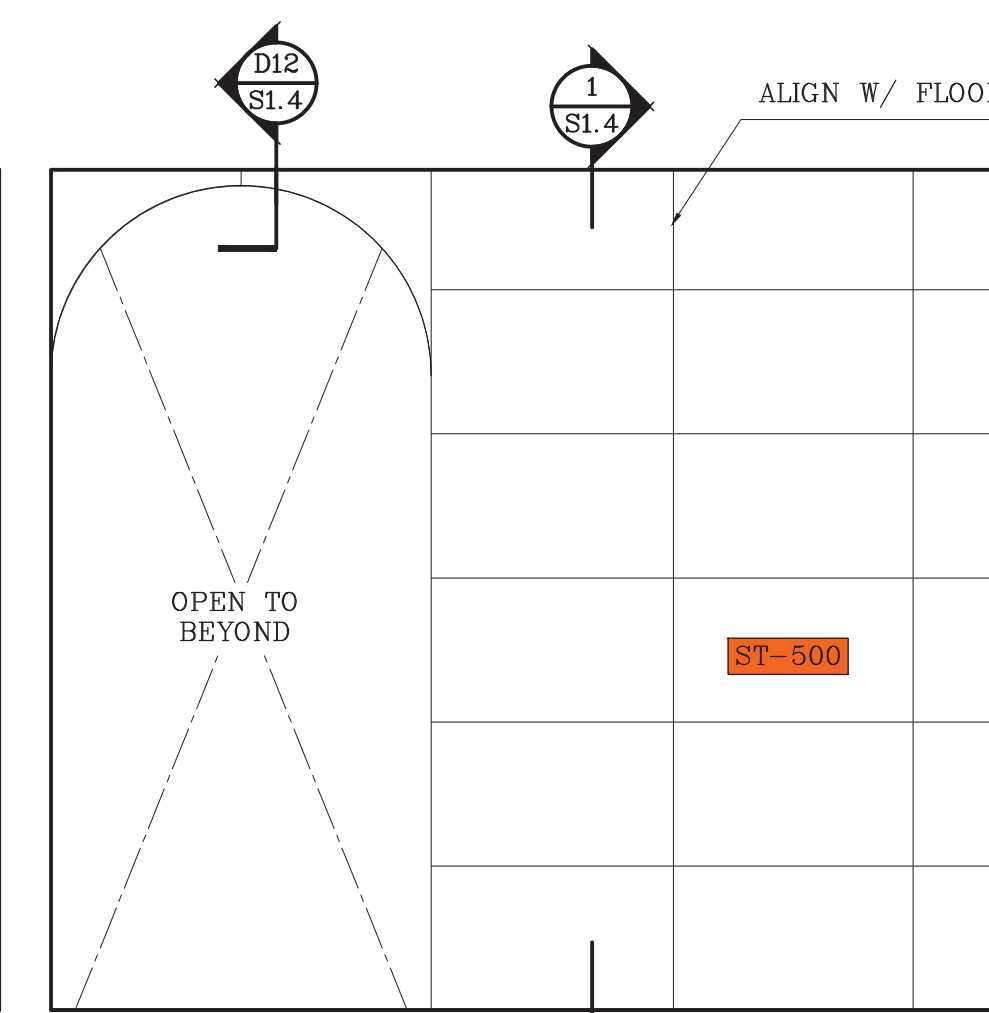

Q ELEVATION  
SCALE: 1/4"=1'-0"

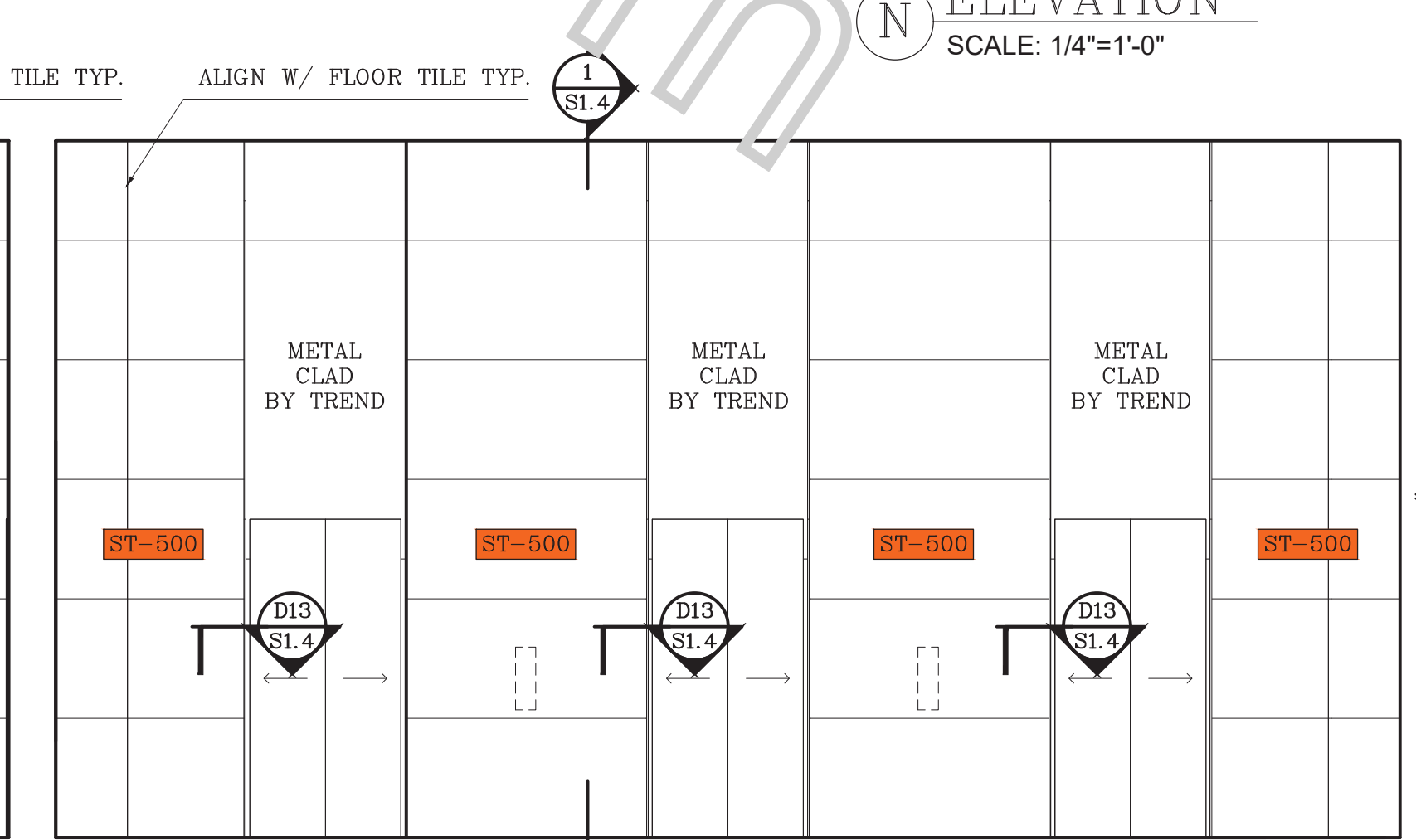

R ELEVATION  
SCALE: 1/4"=1'-0"

SPECIFICATIONS	
FINISHES	
ST-500	TRAVERTINE - MARE CLASSISCO HONED
HARDWARE	
FIXTURES	

APPROVED/NO CHANGES  
APPROVED/AS NOTED  
REVISE AS NOTED/RESUBMIT

SIGNATURE \_\_\_\_\_ DATE \_\_\_\_\_

REVISIONS			
Nr.	DATE	DESCRIPTION	OBS.

ONCE APPROVED, THIS DRAWING  
SUPERSEDES ALL PREVIOUS  
ARCHITECTURAL & SHOP DRAWINGS

APPROVED BY:

SIGNATURE \_\_\_\_\_ DATE \_\_\_\_\_

ABBREVIATIONS	
AF=Above Fin Floor	FE=Finished End
BS=Base	FF=Face Frame
BC=Back	FO=Finished Opening
CAB=Cabinet	FP=Fixed Panel
CAS=Casing	ID=Inner Dimension
CL=Clear Opening	OD=Outer Dimension
CTOP=Counter Top	PNL=Panel
DB=Drawer Box	RO=Rough Opening
DF=Drawer Face	POT=Pull Out Tray
WF=Work In Field	REM=Removable Panel
FD=Field Dimension	SHF=Adj. Shelf

PROJECT: \_\_\_\_\_

LOCATION: \_\_\_\_\_

COMPANY: \_\_\_\_\_

LEVEL 1  
STONE SHOP DRWG.

DWN BY: DAN SCALE: AS NOTED DWG. NO.: S1.2

DATE: 08/15/2023

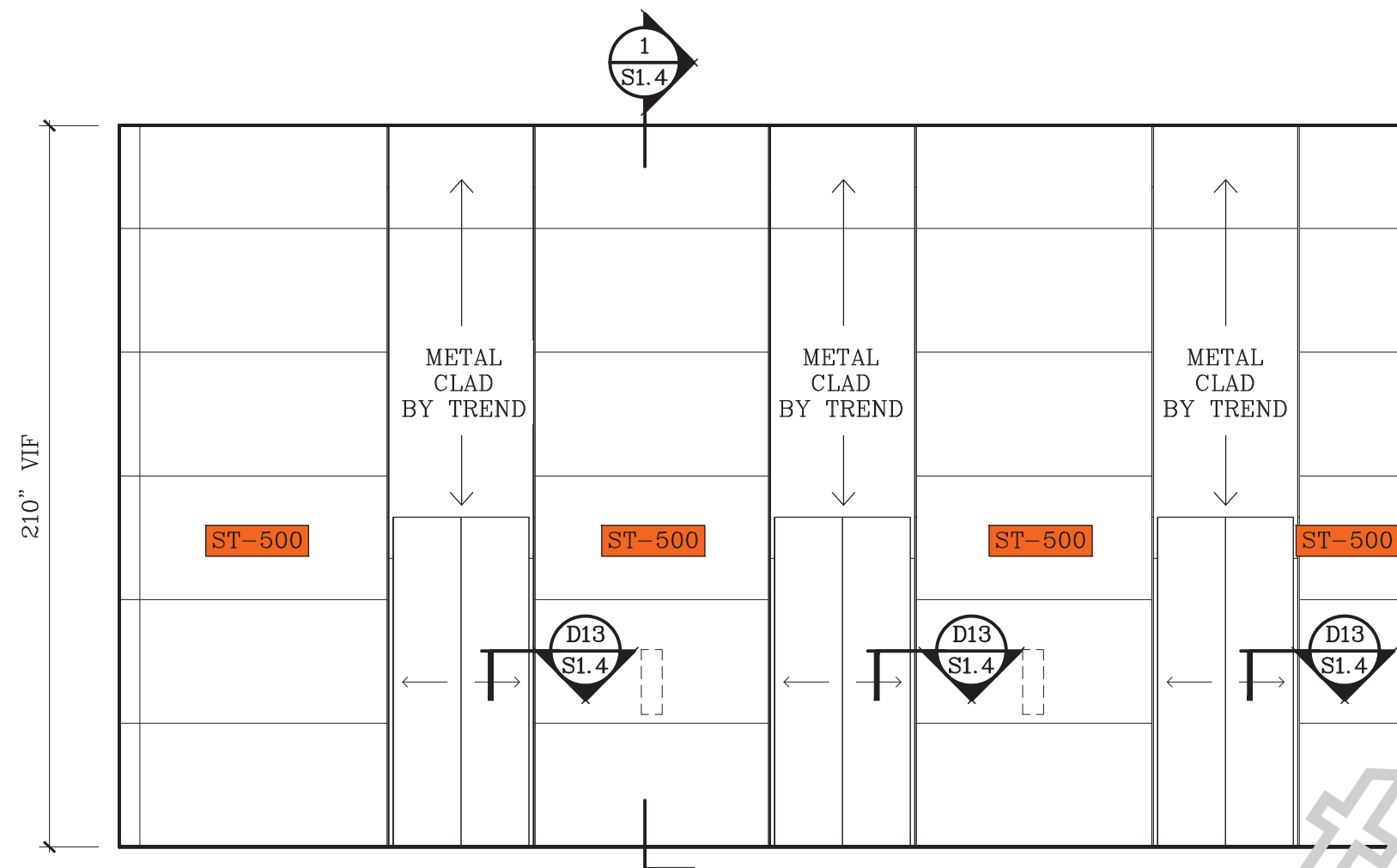

**S** ELEVATION  
SCALE: 1/4"=1'-0"

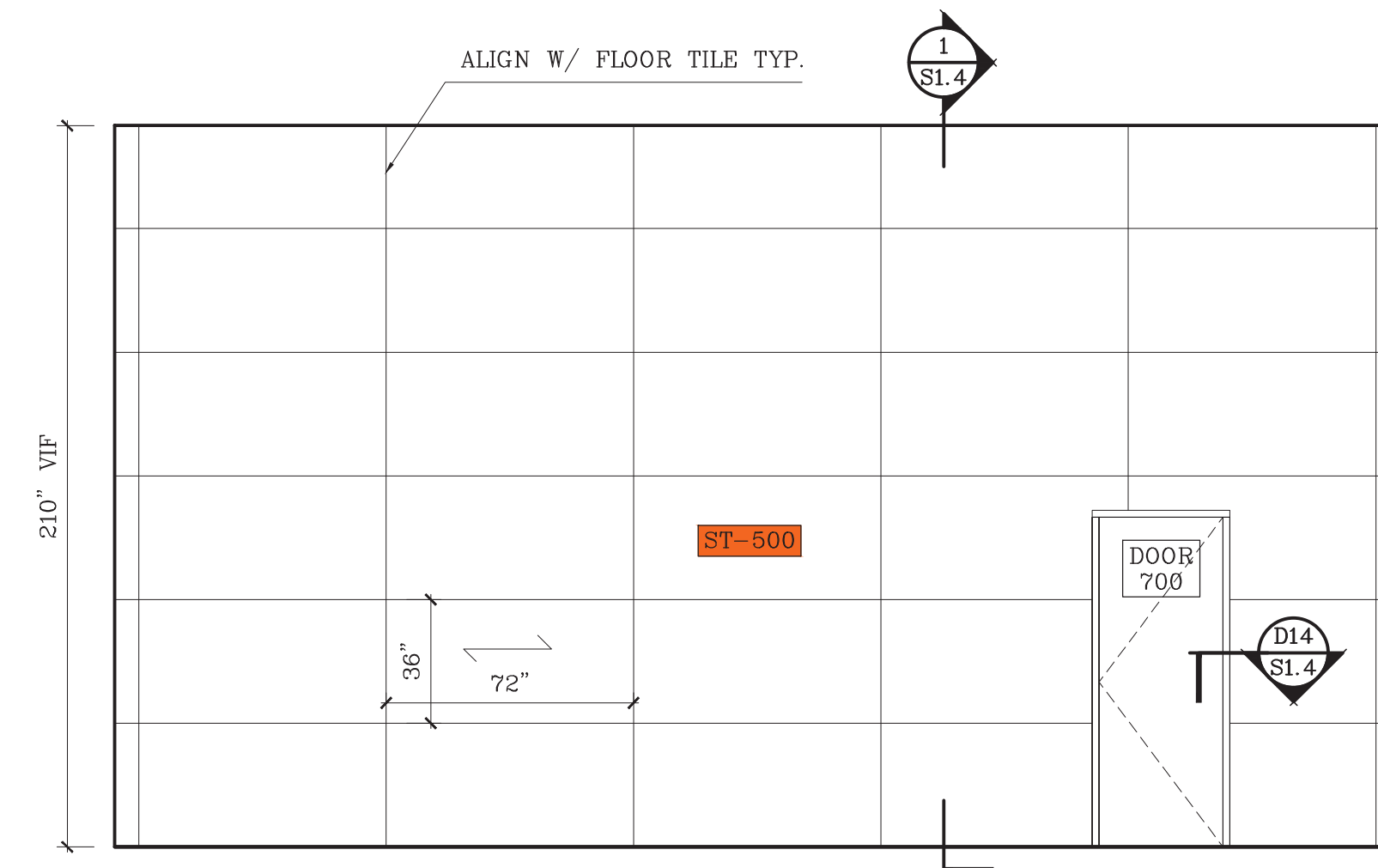

**T** ELEVATION  
SCALE: 1/4"=1'-0"

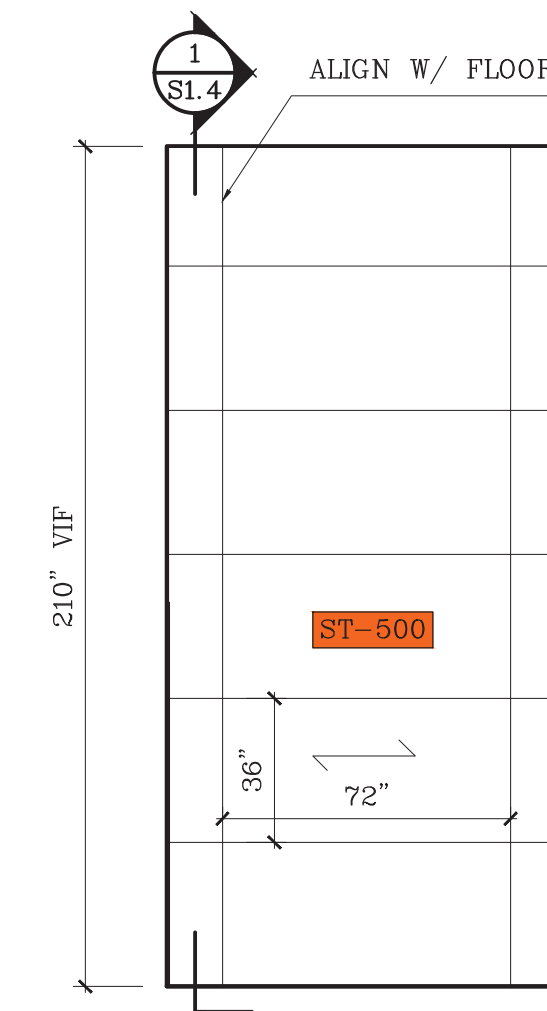

**U** ELEVATION  
SCALE: 1/4"=1'-0"

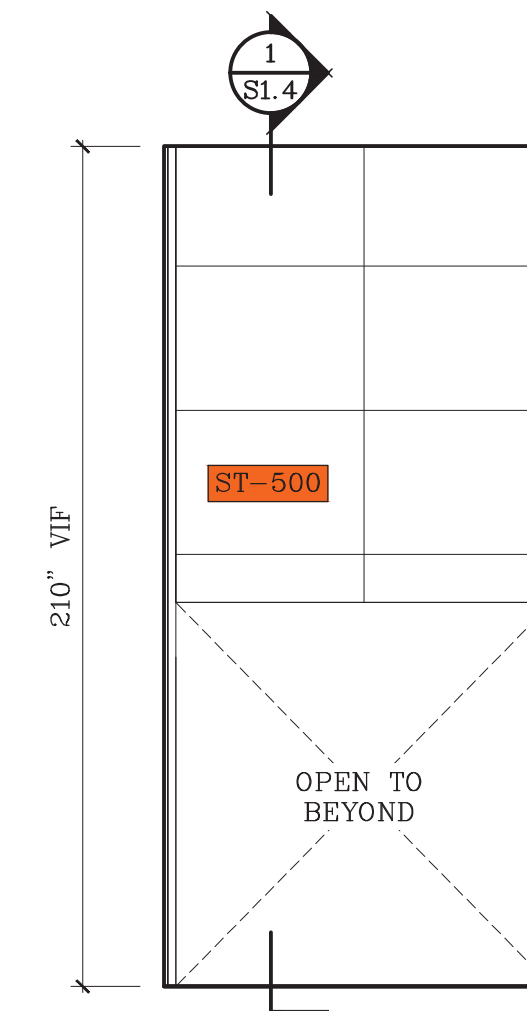

**V** ELEVATION  
SCALE: 1/4"=1'-0"

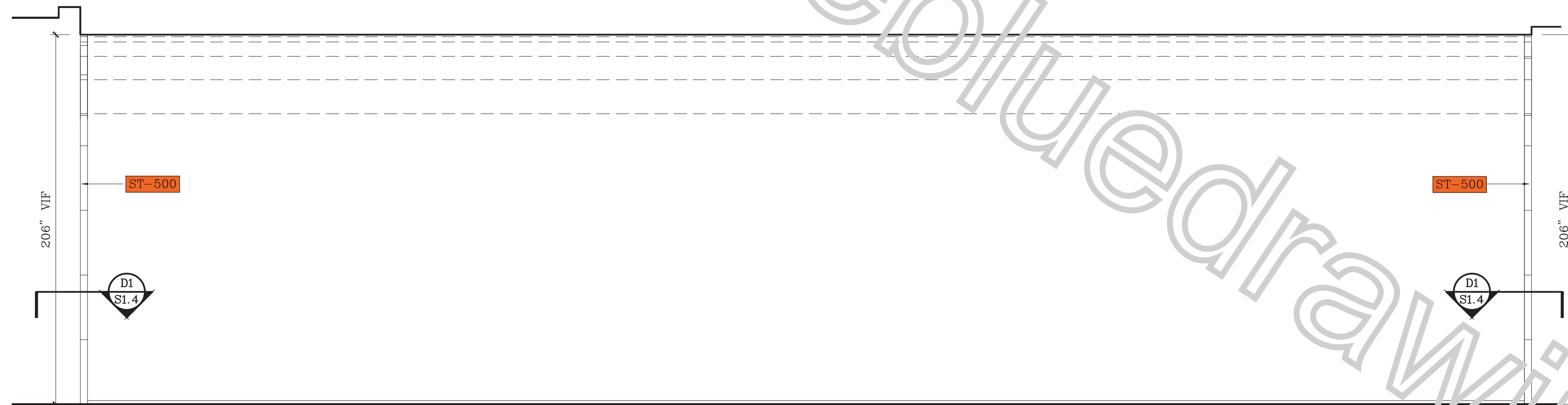

**W** ELEVATION  
SCALE: 1/4"=1'-0"

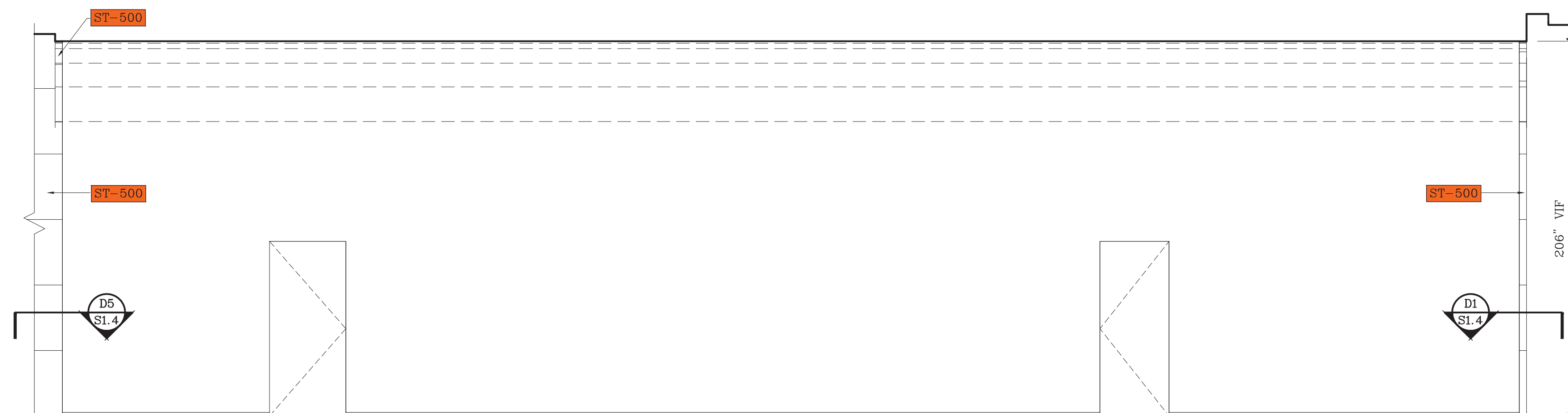

**X** ELEVATION  
SCALE: 1/4"=1'-0"

**SPECIFICATIONS**

FINISHES	
<b>ST-500</b>	TRAVERTINE - MARE CLASSISCO HONED
HARDWARE	
FIXTURES	

APPROVED/NO CHANGES  
APPROVED/AS NOTED  
REVISE AS NOTED/RESUBMIT

SIGNATURE \_\_\_\_\_ DATE \_\_\_\_\_

**REVISIONS**

Nr.	DATE	DESCRIPTION	BY	OBS.

ONCE APPROVED, THIS DRAWING  
SUPERSEDES ALL PREVIOUS  
ARCHITECTURAL & SHOP DRAWINGS

APPROVED BY:

SIGNATURE \_\_\_\_\_ DATE \_\_\_\_\_

**ABBREVIATIONS**

AFF=Above Fin Floor	FE=Finished End
BS=Base	FF=Face Frame
BOX=Box	FO=Finished Opening
CAB=Cabinet	FP=Fixed Panel
CAS=Casing	ID=Inner Dimension
CL=Clear Opening	OD=Outer Dimension
CTOP=Counter Top	PNL=Panel
DB=Drawer Box	RO=Rough Opening
DF=Drawer Face	PO=Pull Out Tray
WF=Verify in Field	RM=Removable Panel
FD=Field Dimension	SF=Adj. Shelf

PROJECT \_\_\_\_\_

LOCATION \_\_\_\_\_

COMPAN \_\_\_\_\_

**LEVEL 1**  
**STONE SHOP DRWG.**

DWN BY: DAN	SCALE: AS NOTED	DWG. NO.:
DATE: 08/15/2023		S1.3

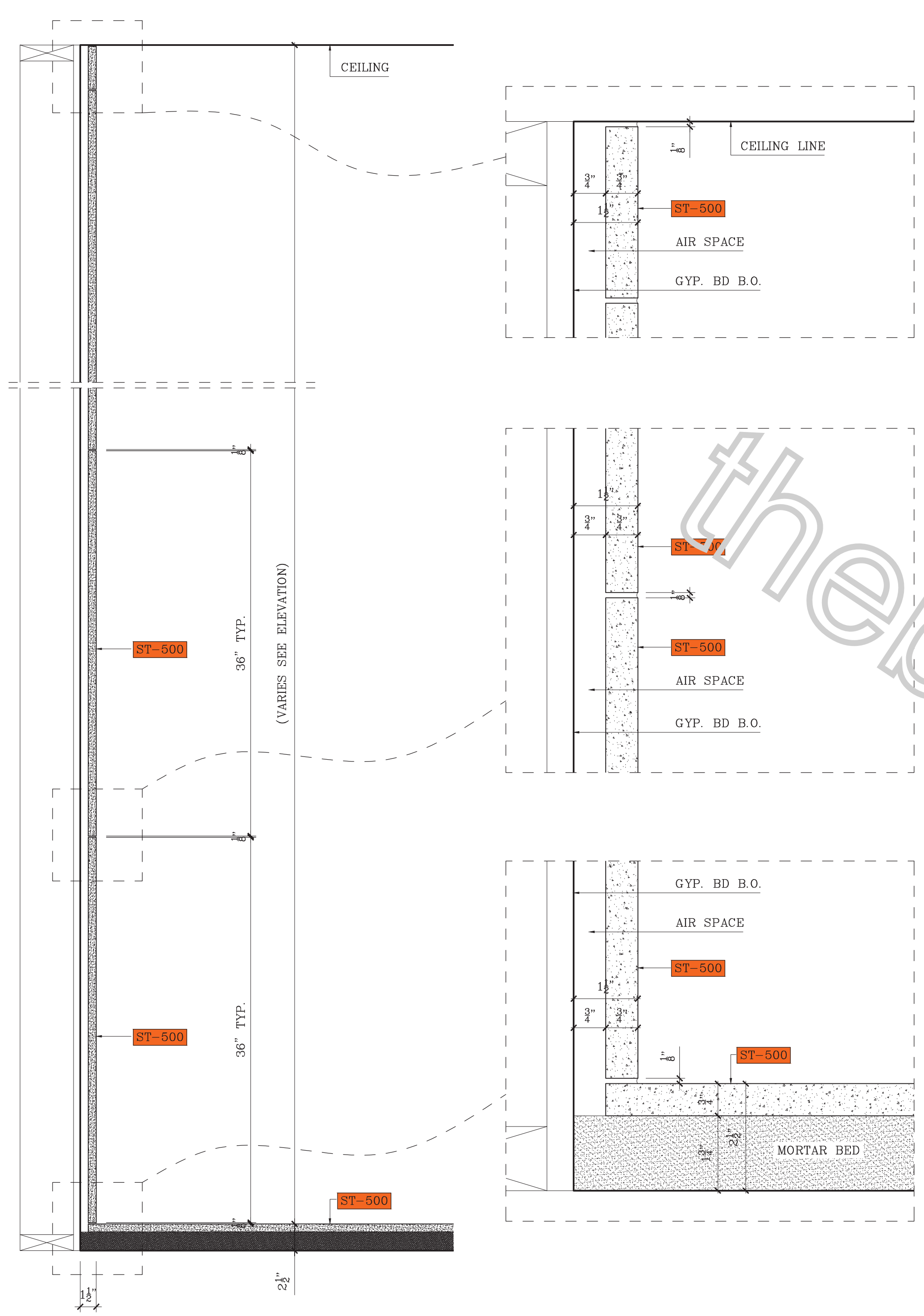

1 VERTICAL SECTION  
SCALE: 1 1/2"=1'-0"

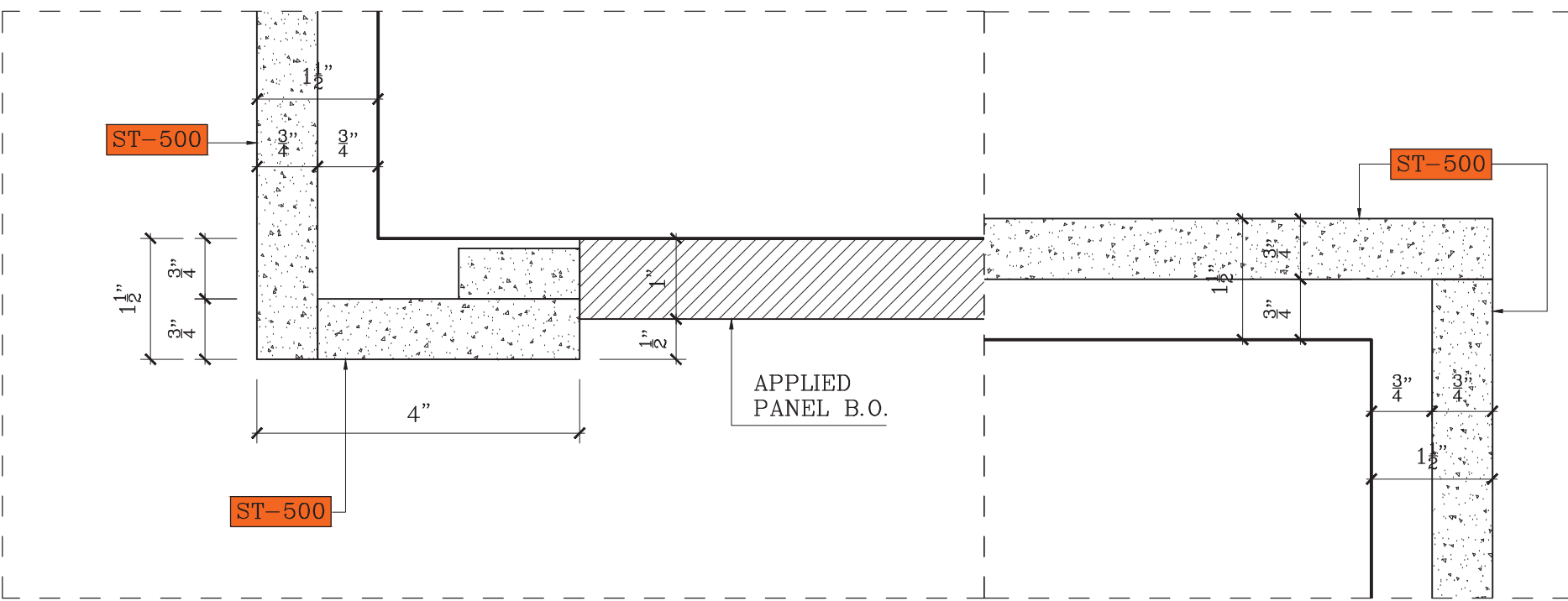

D1 PLAN DETAIL  
SCALE: 6"=1'-0"

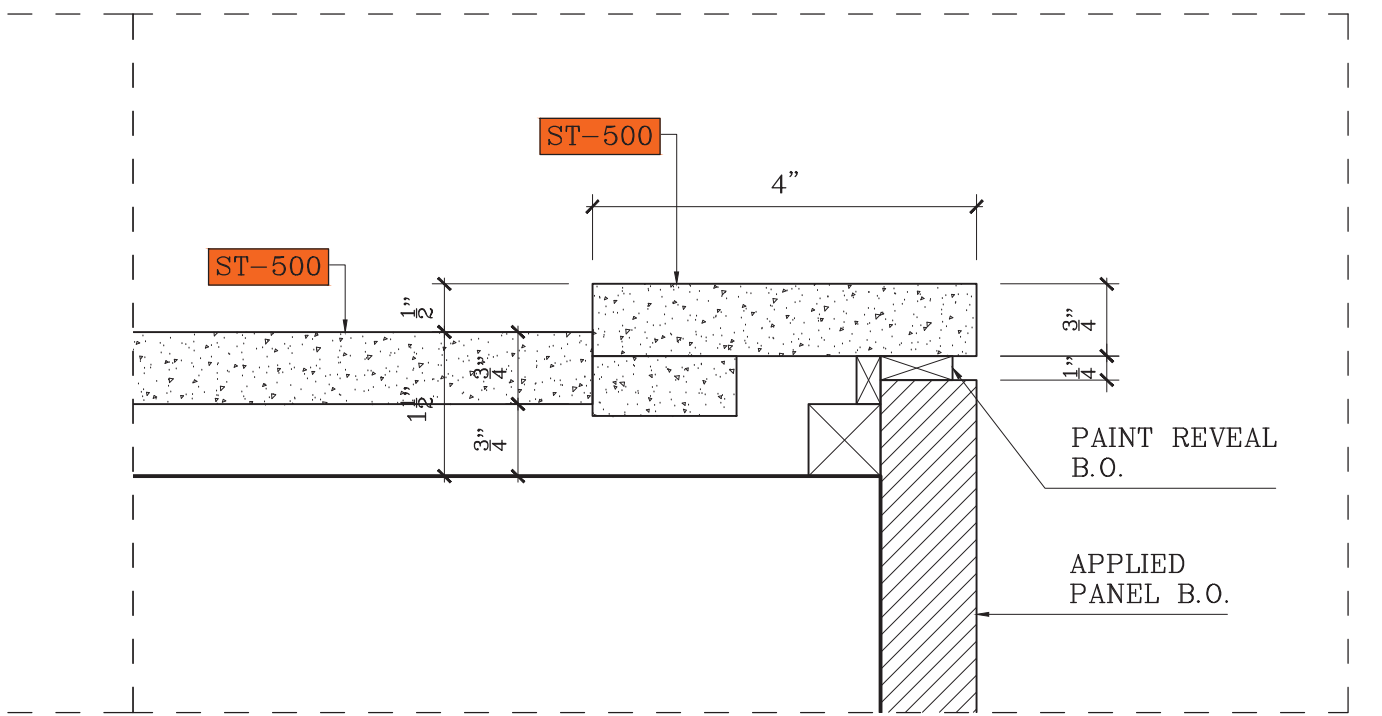

D2 PLAN DETAIL  
SCALE: 6"=1'-0"

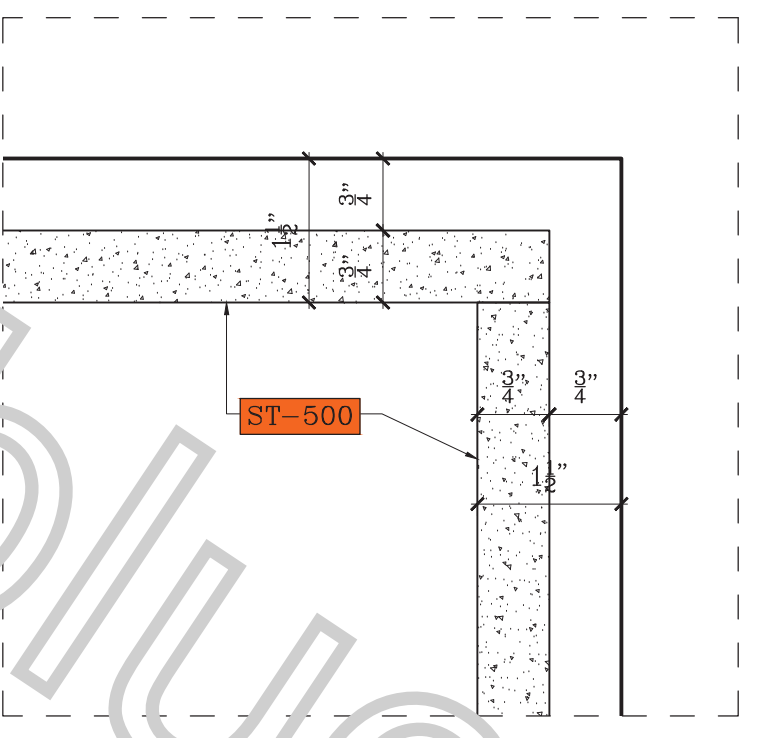
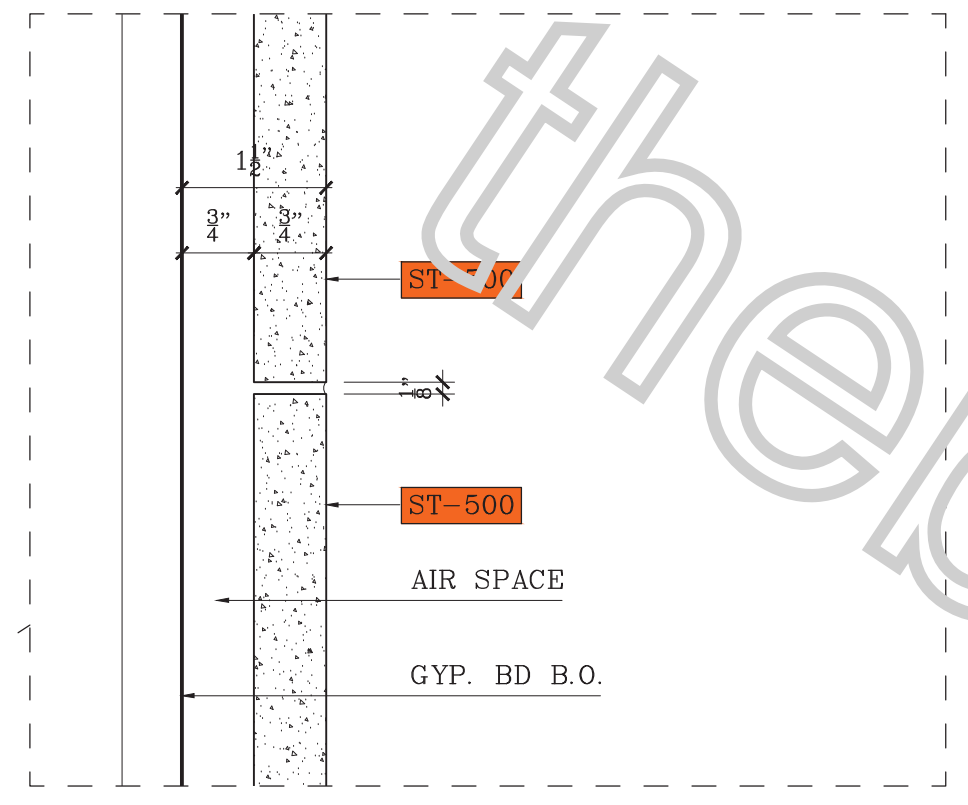

D4 PLAN DETAIL  
SCALE: 6"=1'-0"

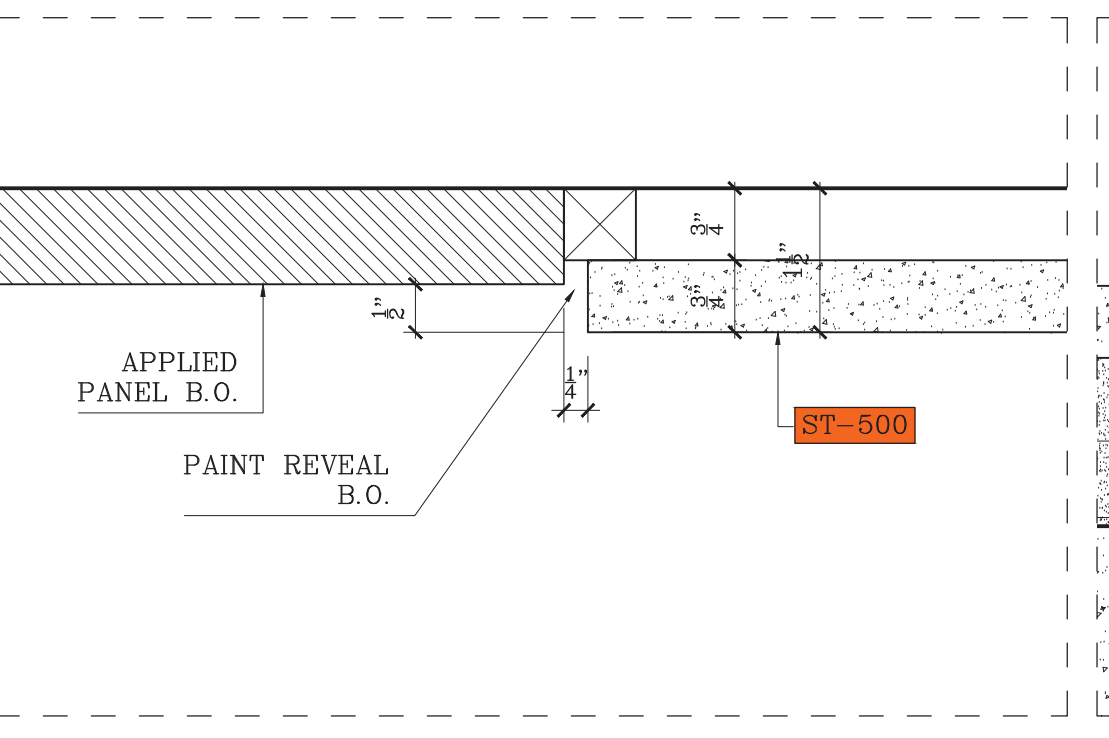

D5 PLAN DETAIL  
SCALE: 6"=1'-0"

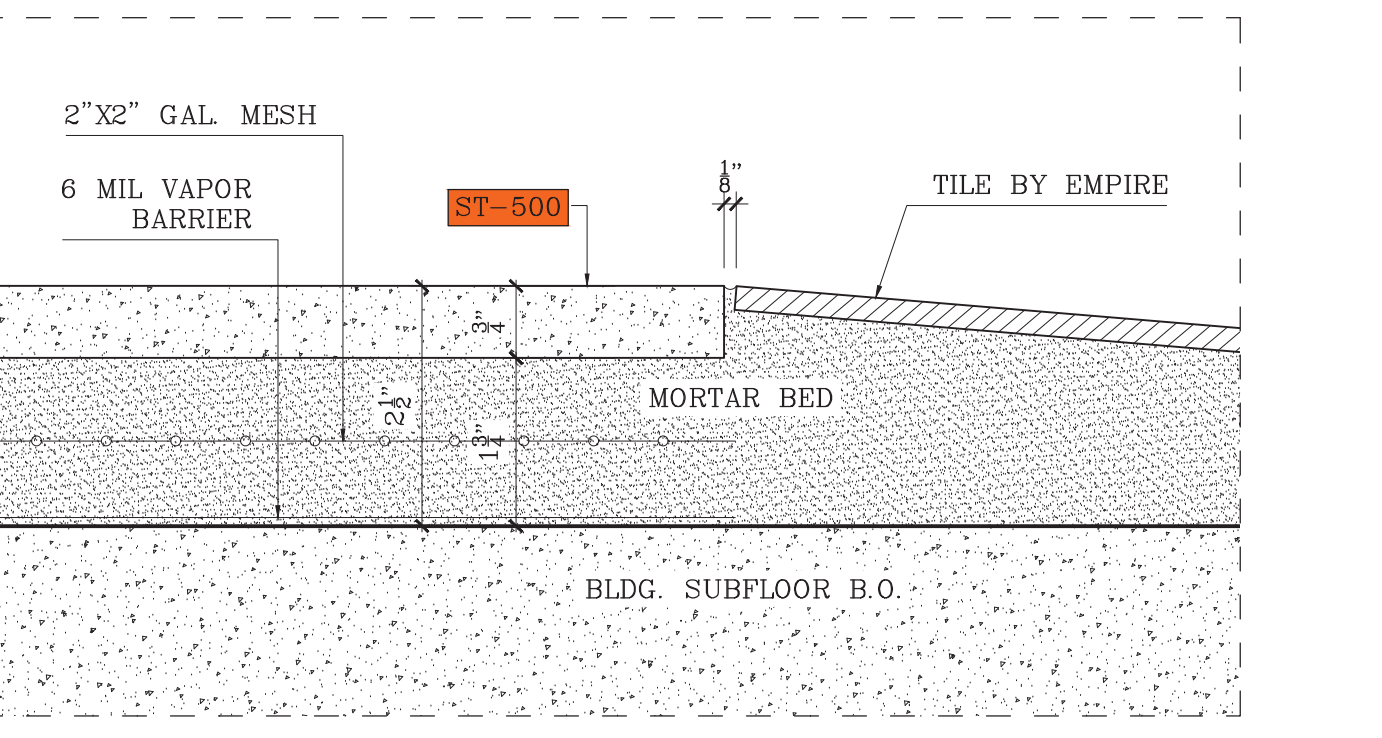

D6 VERTICAL DETAIL  
SCALE: 6"=1'-0"

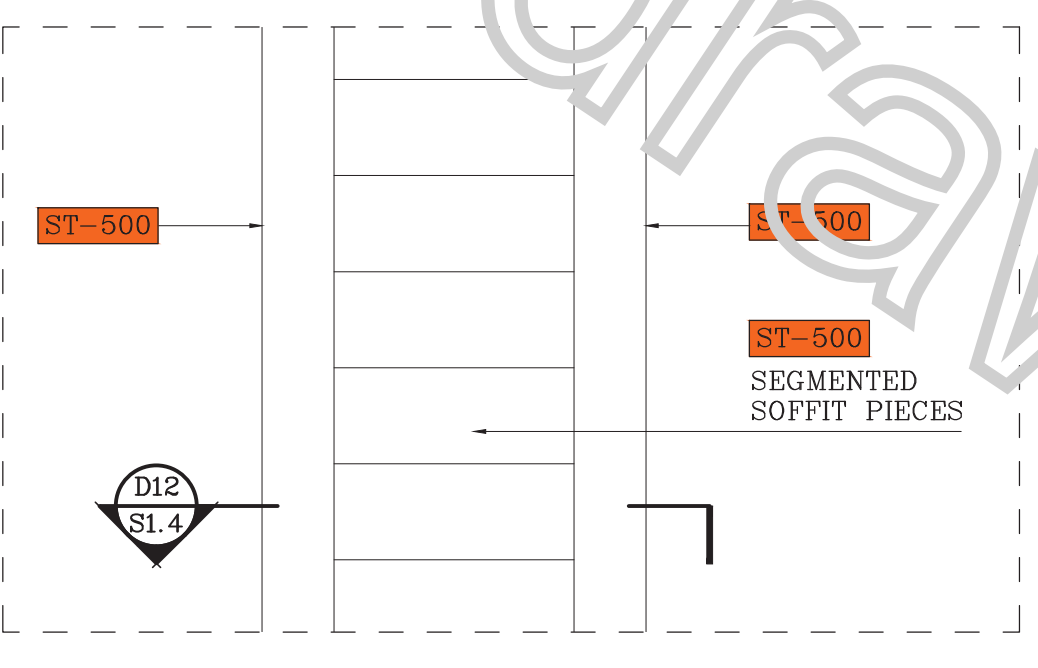
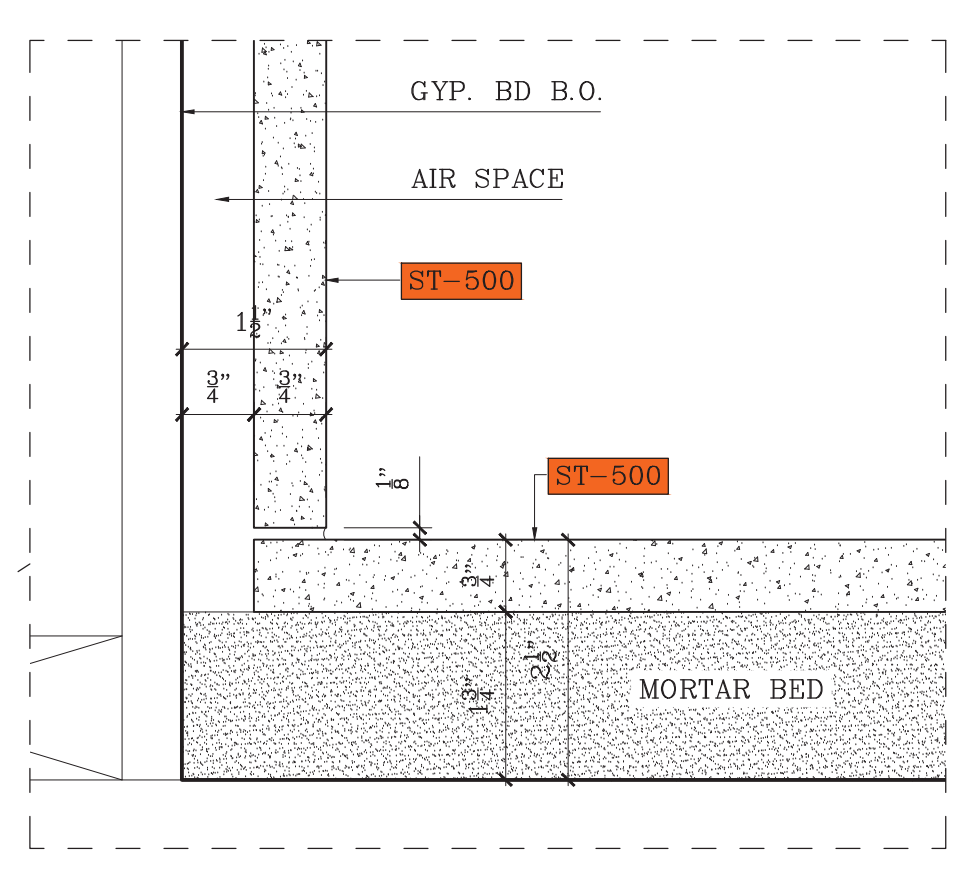

D11 REFL. CLG. PLAN PORTAL  
SCALE: 6"=1'-0"

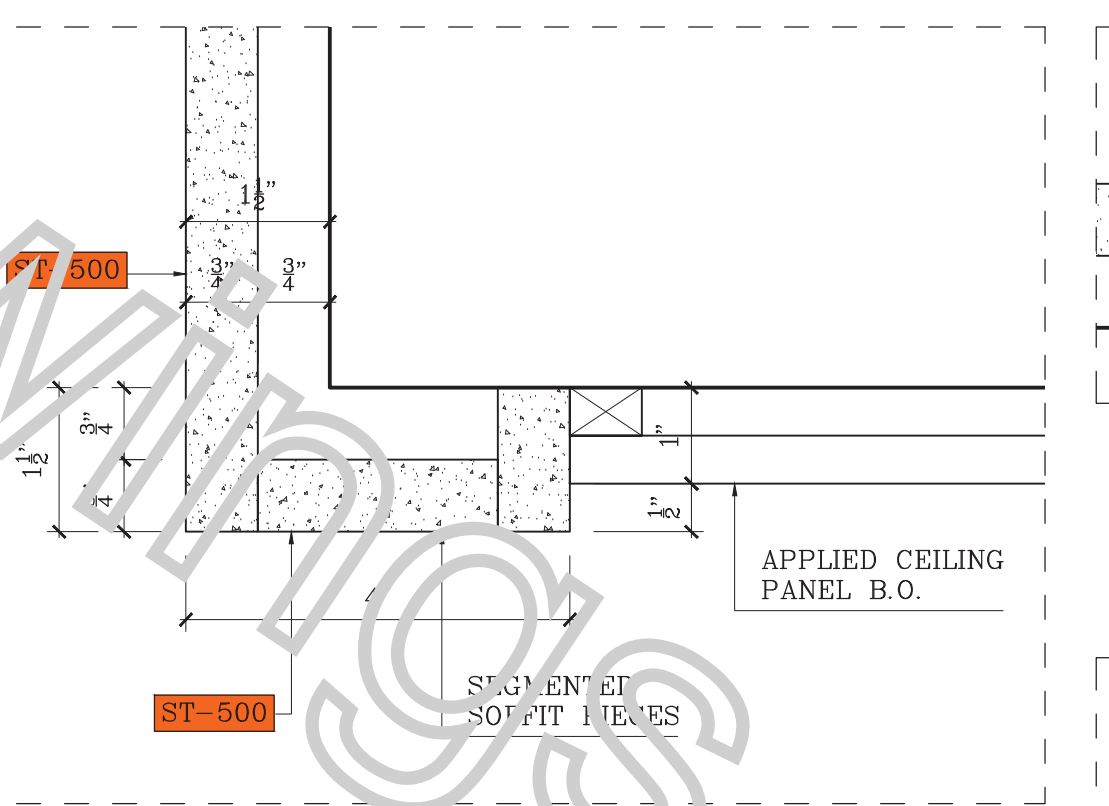

D12 VERTICAL DETAIL  
SCALE: 6"=1'-0"

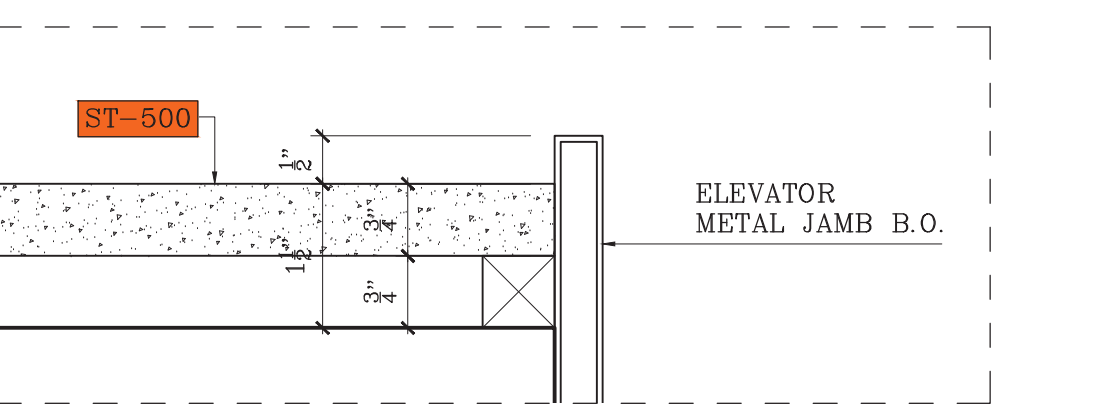

D13 PLAN DETAIL  
SCALE: 6"=1'-0"

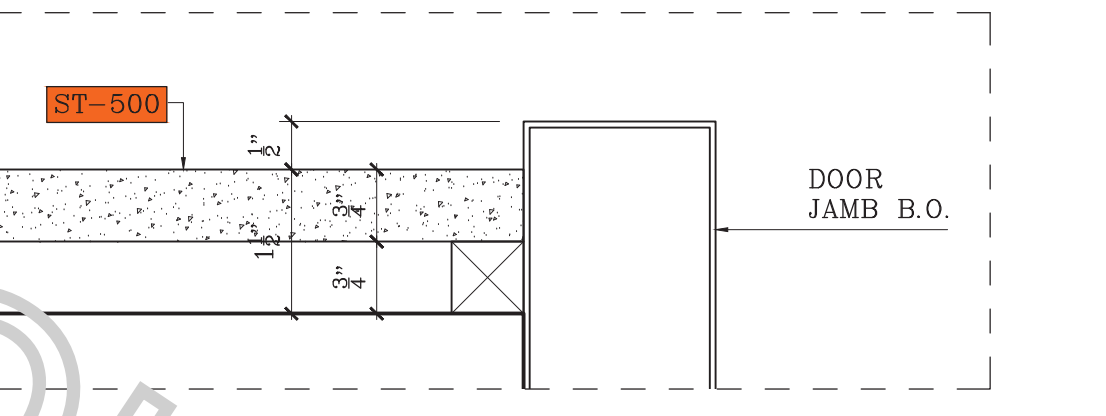

D14 PLAN DETAIL  
SCALE: 6"=1'-0"

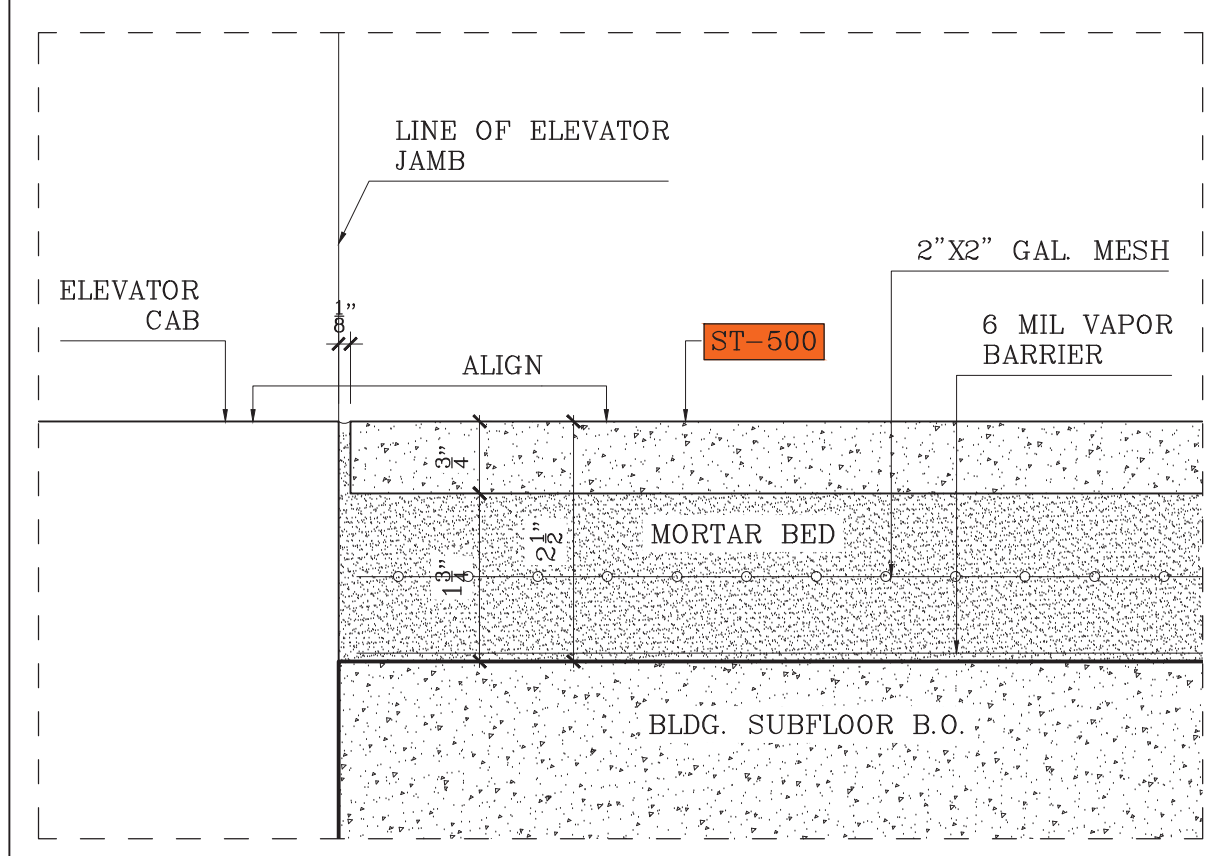

D7 VERTICAL DETAIL  
SCALE: 6"=1'-0"

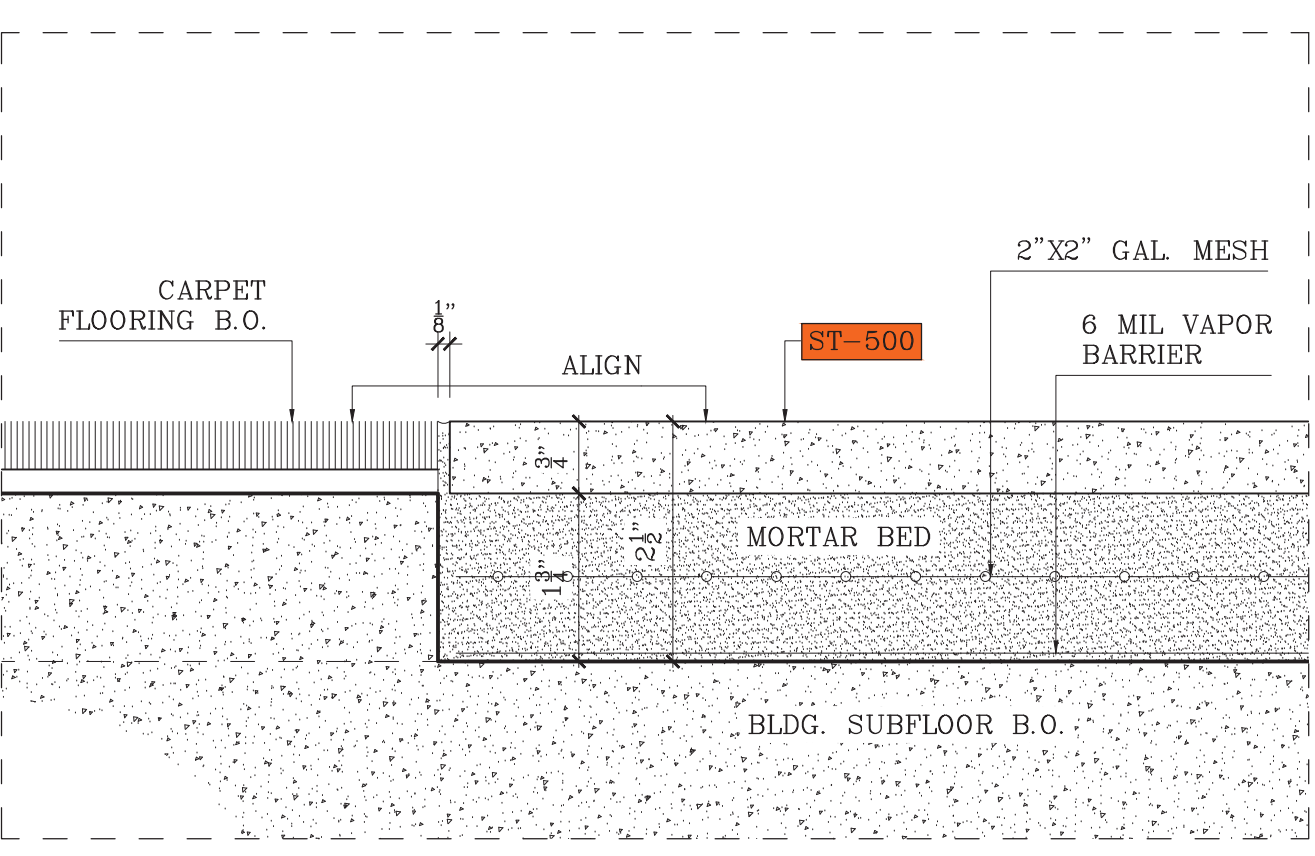

D8 VERTICAL DETAIL  
SCALE: 6"=1'-0"

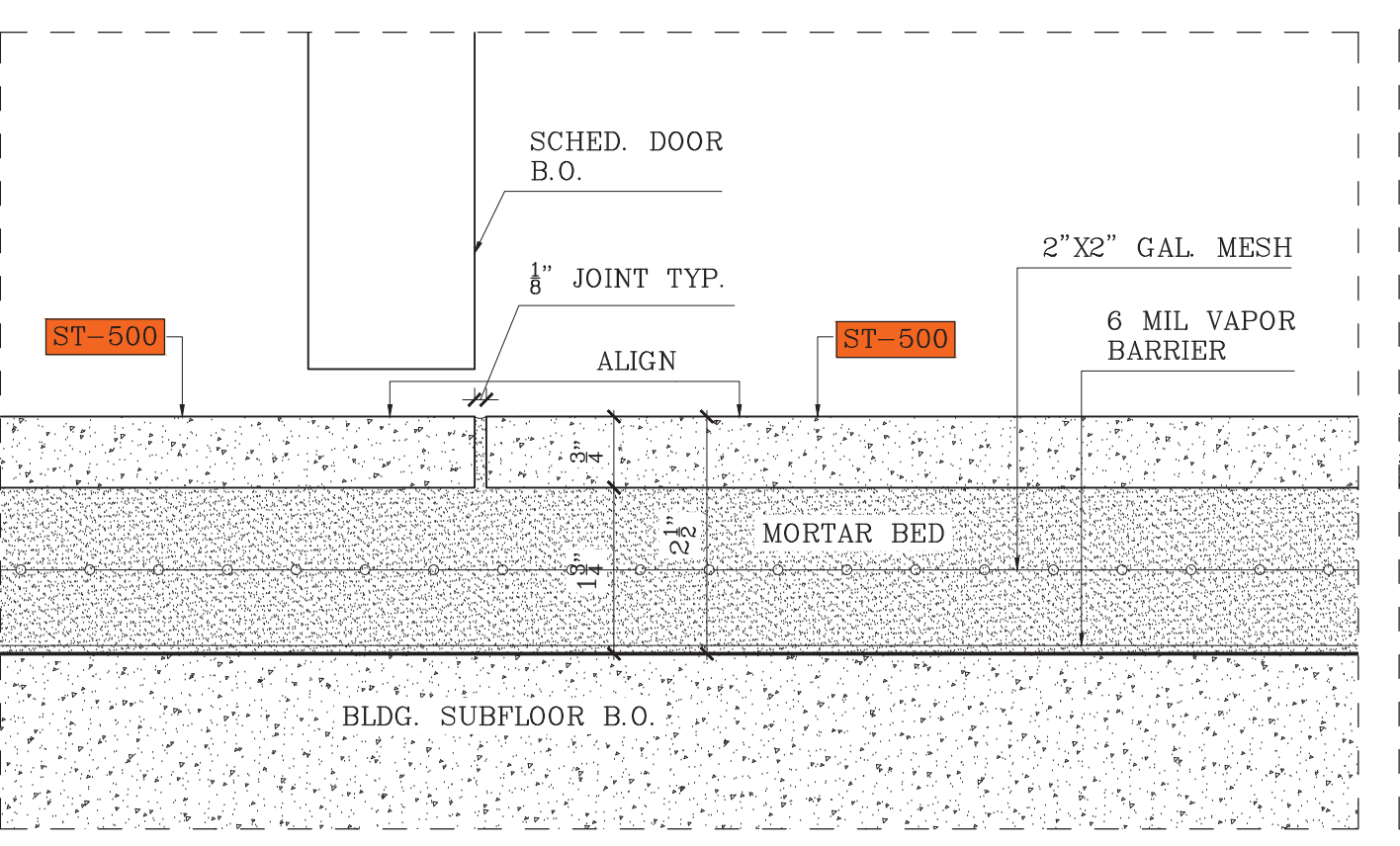

D9 VERTICAL DETAIL  
SCALE: 6"=1'-0"

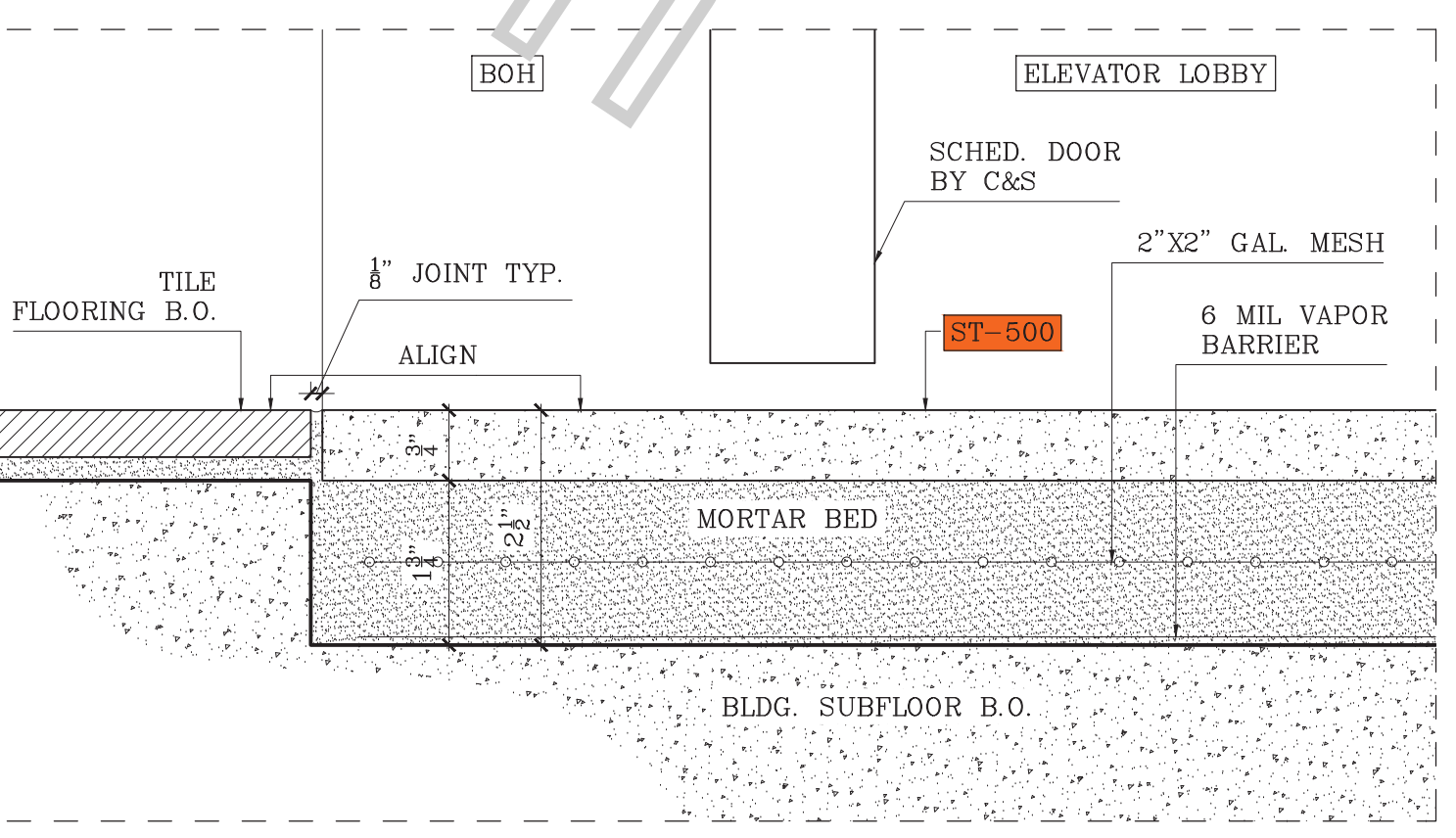

D10 VERTICAL DETAIL  
SCALE: 6"=1'-0"

SPECIFICATIONS

FINISHES

ST-500	TRAVERTINE - MARE CLASSISCO HONED

HARDWARE

FIXTURES

APPROVED/NO CHANGES  
APPROVED/AS NOTED  
REVISE AS NOTED/RESUBMIT

SIGNATURE \_\_\_\_\_ DATE \_\_\_\_\_

REVISIONS

Nr.	DATE	DESCRIPTION	BY	OBS.

ONCE APPROVED, THIS DRAWING SUPERSEDES ALL PREVIOUS ARCHITECTURAL & SHOP DRAWINGS

APPROVED BY: \_\_\_\_\_

SIGNATURE \_\_\_\_\_ DATE \_\_\_\_\_

ABBREVIATIONS

AFF=Above Fin Floor	FE=Finished End
BSI=Base	FF=Face Frame
BCK=Back	FO=Finished Opening
CAB=Cabinet	FP=Fixed Panel
CAS=Casing	ID=Inner Dimension
CL=Clear Opening	OD=Outer Dimension
CTOP=Counter Top	PNL=Panel
DB=Drawer Box	RO=Rough Opening
DF=Drawer Face	POT=Pull Out Tray
WF=Work in Field	REM=Removable Panel
FD=Field Dimension	SHF=Adj. Shelf

PROJECT: \_\_\_\_\_

LOCATI: \_\_\_\_\_

COMP: \_\_\_\_\_

LEVEL 1  
STONE SHOP DRWG.

DWN BY: DAN	SCALE: AS NOTED	DWG. NO.: S1.4
DATE: 08/15/2023		

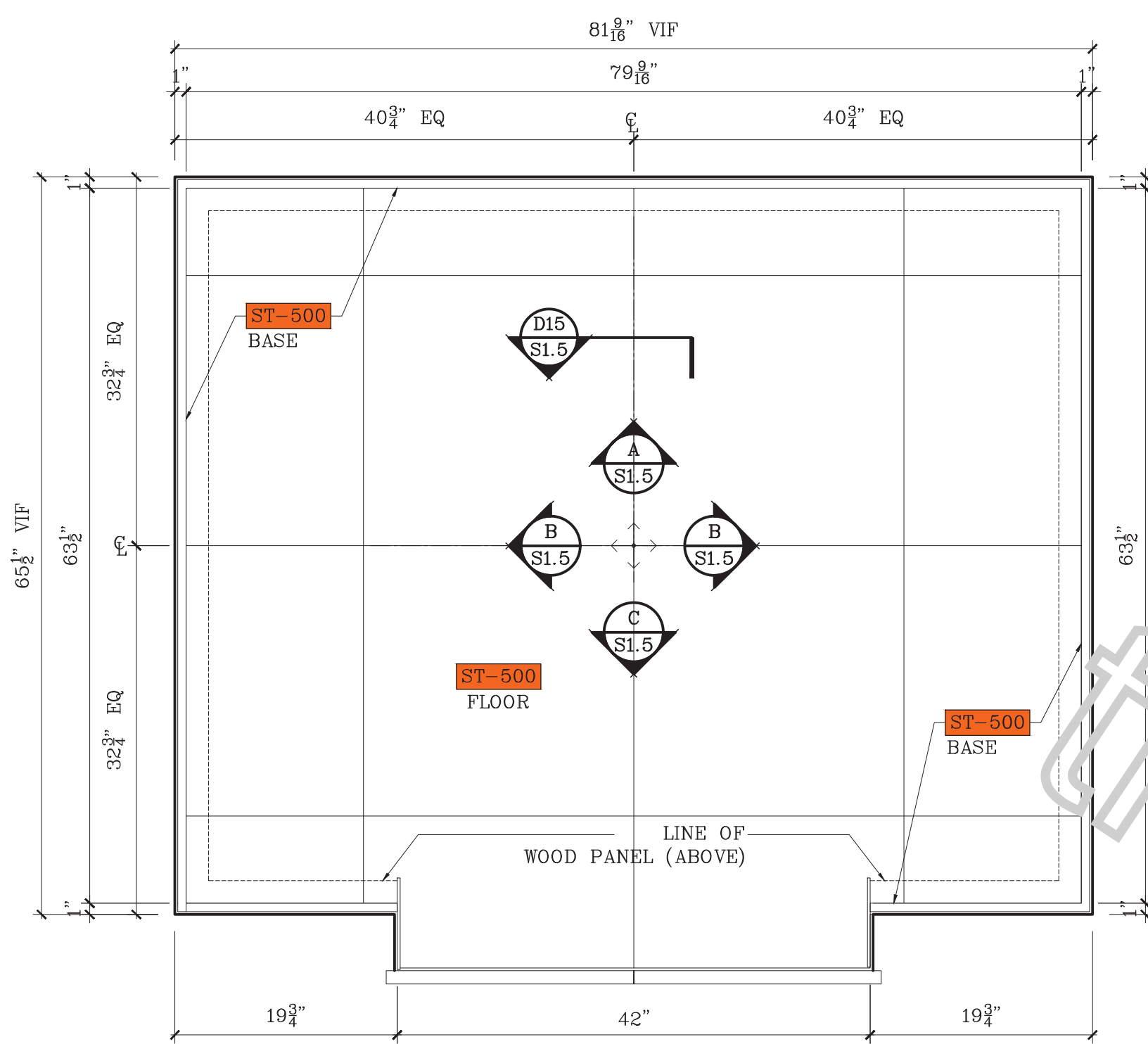

1 PLAN @ ELEVATOR CAB  
SCALE: 1"=1'-0"

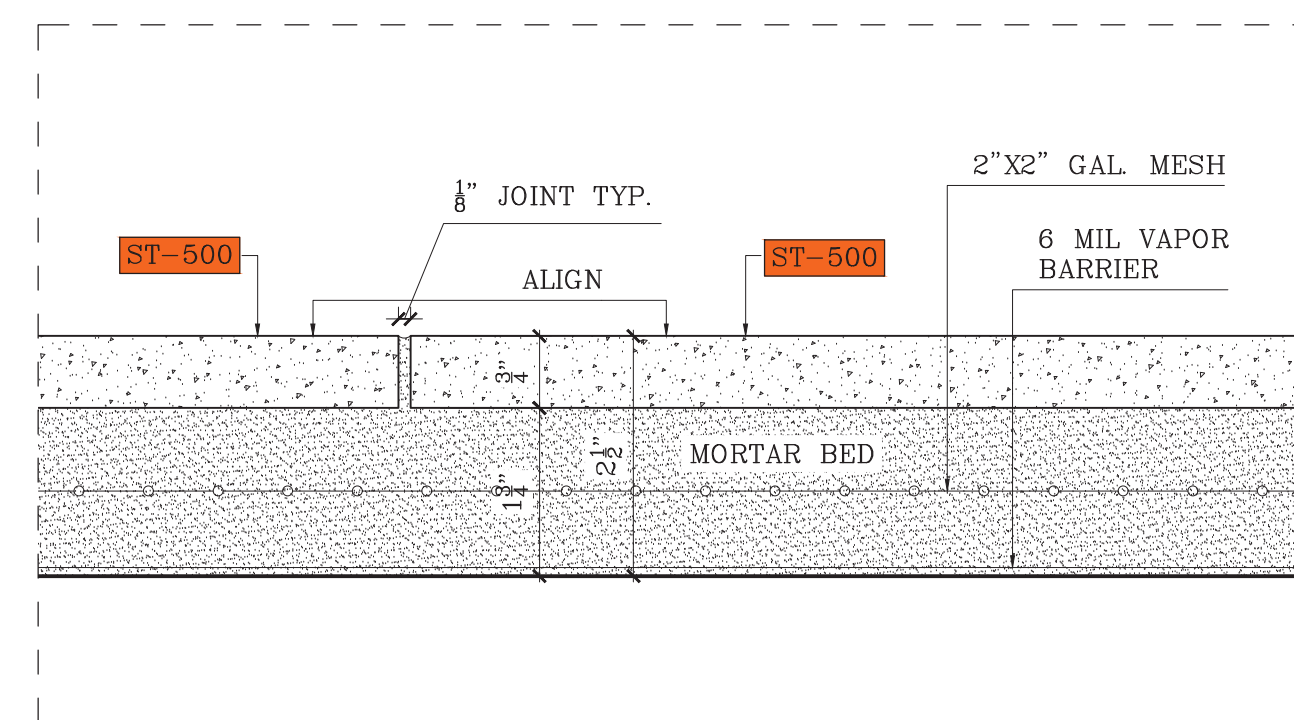

D15 VERTICAL DETAIL  
SCALE: 6"=1'-0"

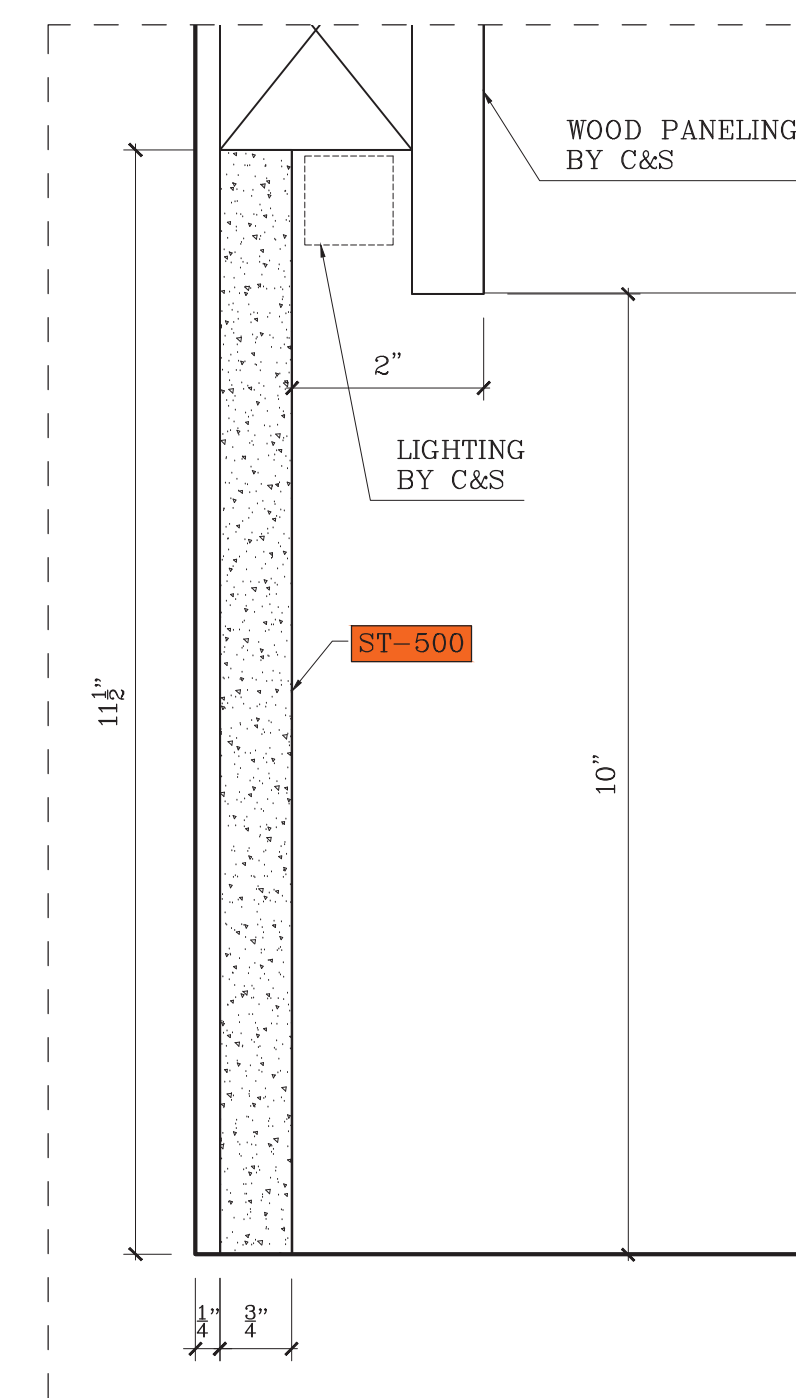

D16 VERTICAL DETAIL  
SCALE: 6"=1'-0"

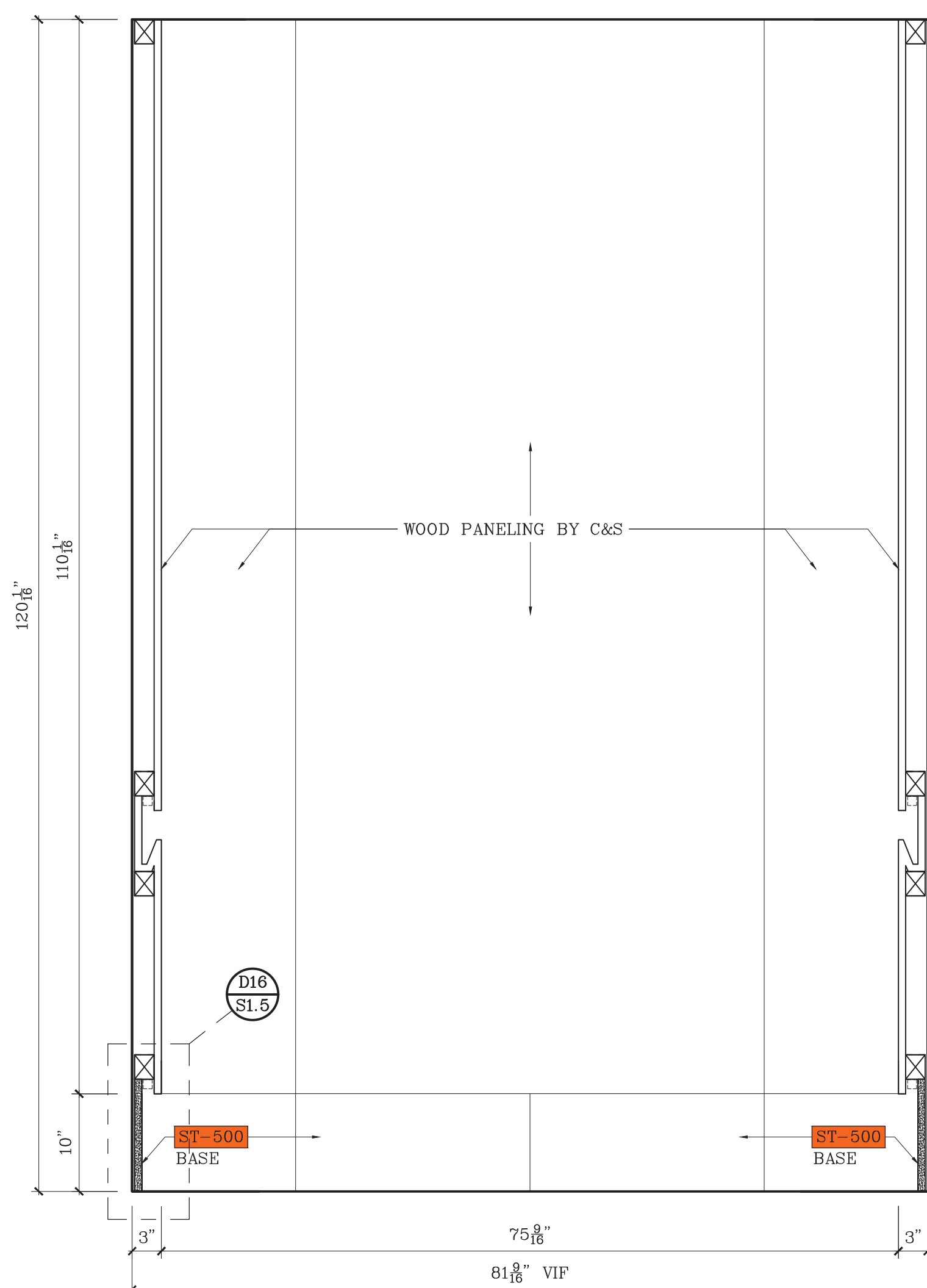

A ELEVATION  
SCALE: 1"=1'-0"

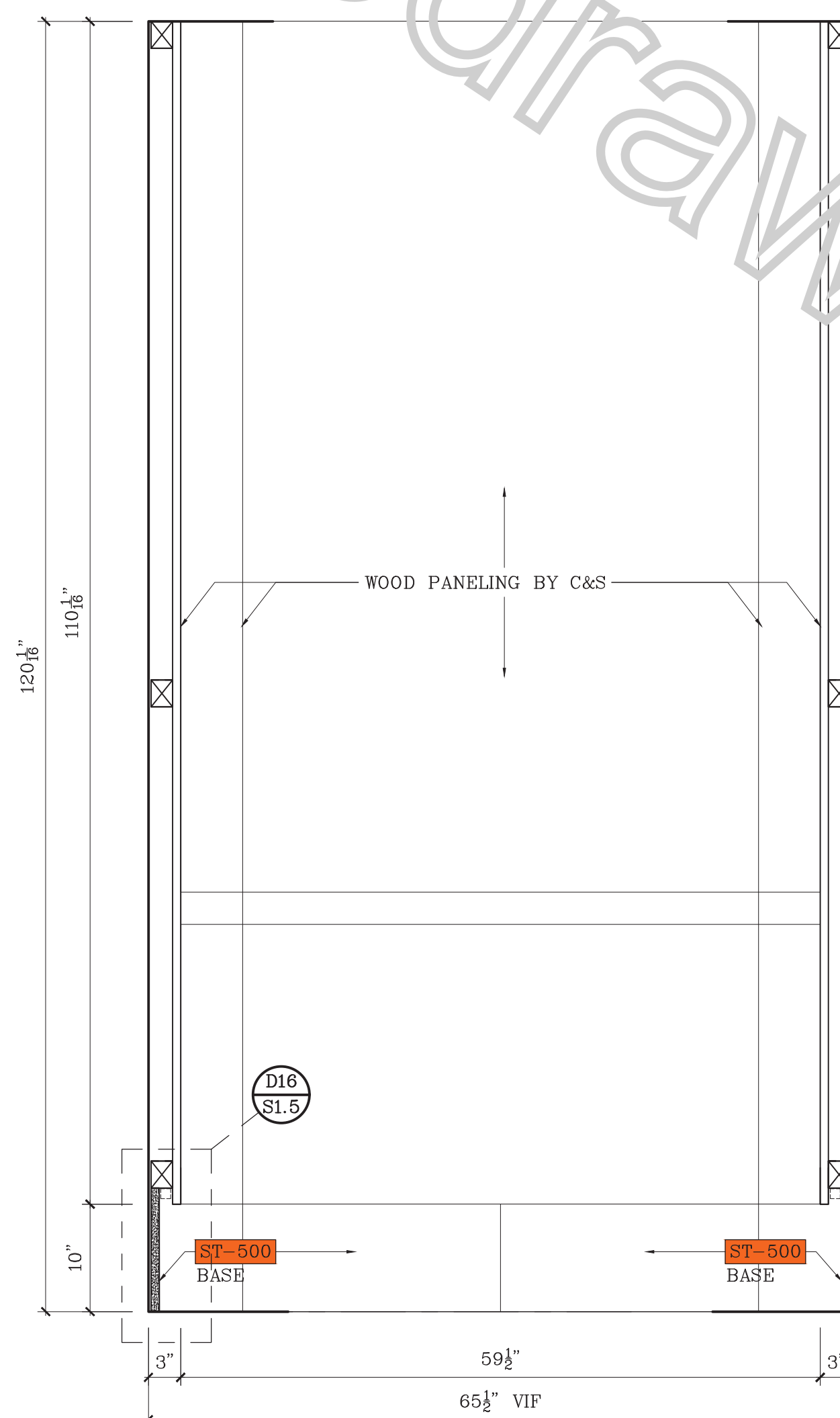

B ELEVATION  
SCALE: 1"=1'-0"

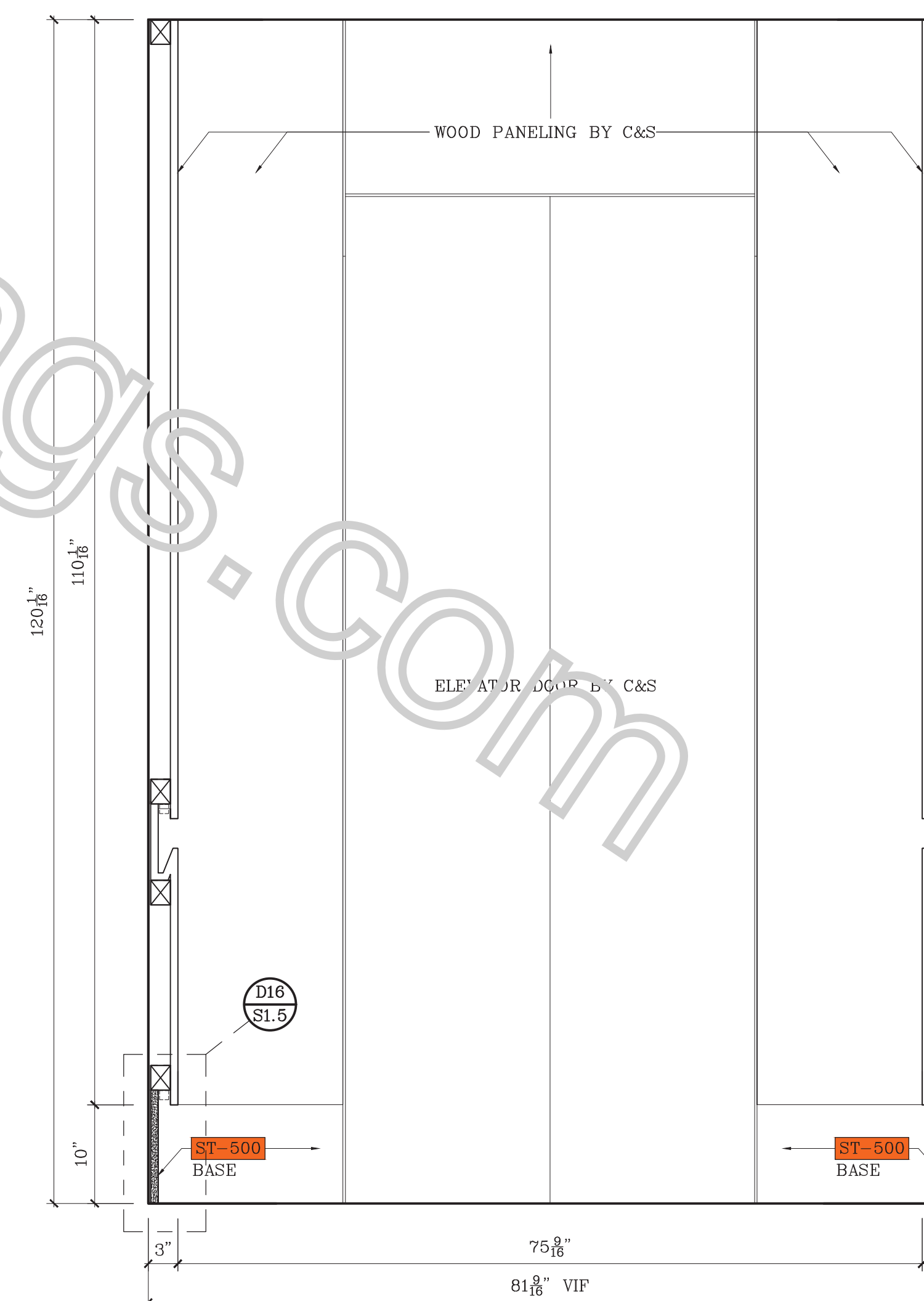

C ELEVATION  
SCALE: 1"=1'-0"

SPECIFICATIONS

FINISHES

ST-500 TRAVERTINE - MARE CLASSISCO HONED

HARDWARE

FIXTURES

APPROVED/NO CHANGES  
APPROVED/AS NOTED  
REVISE AS NOTED/RESUBMIT

SIGNATURE \_\_\_\_\_ DATE \_\_\_\_\_

REVISIONS

Nr.	DATE	DESCRIPTION	BY	OBS.

ONCE APPROVED, THIS DRAWING  
SUPERSEDES ALL PREVIOUS  
ARCHITECTURAL & SHOP DRAWINGS

APPROVED BY:

SIGNATURE \_\_\_\_\_ DATE \_\_\_\_\_

ABBREVIATIONS

AF=Above Fin Floor	FE=Finished End
BS=Base	FF=Face Frame
BC=Back	FO=Finished Opening
C&S=Cabinet	FP=Fixed Panel
C&S=Casing	ID=Inner Dimension
CL=Clear Opening	OD=Outer Dimension
CTOP=Counter Top	PNL=Panel
DB=Drawer Box	RO=Rough Opening
DF=Drawer Face	POT=Pull Out Tray
WF=Verify in Field	REM=Removable Panel
FD=Field Dimension	SHF=Adj. Shelf

PROJECT: \_\_\_\_\_

LOCATION: \_\_\_\_\_

COMPANY: \_\_\_\_\_

LEVEL 1  
STONE SHOP DRWG.

DWN BY: DAN SCALE: AS NOTED DWG. NO.: S1.5  
DATE: 08/15/2023